

KSR-CFK

Circuit Fabrication Kit
KSR Snow Melting Cable

INSTALLATION PROCEDURES

For use with Thermon KSR heating cables.

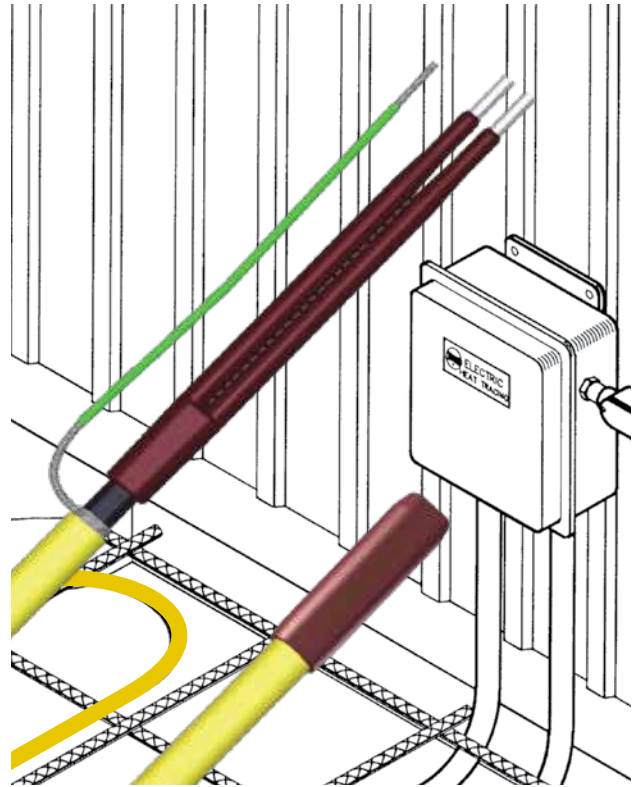

KSR-CFK

The following installation procedures are guidelines for the installation of the Power and End Termination Kit. For translations other than English and local language translation provided here, please contact Thermon. The English language installation procedure shall govern.

Receiving, Storing and Handling

1. Inspect materials for damage incurred during shipping.
2. Report damages to the carrier for settlement.
3. Identify parts against the packing list to ensure the proper type and quantity has been received.
4. Store in a dry location.

KSR-CFK Power and End Termination Kit (per cable)

Kit Contents

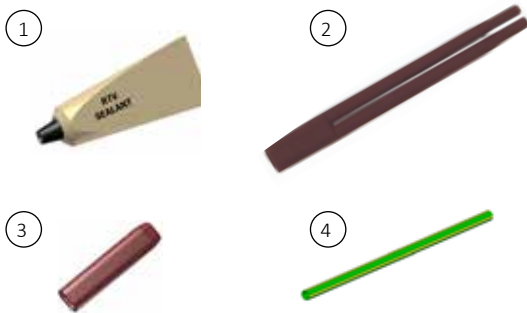

Item	Quantity	Description
1	1	RTV Tube
2	1	Power Connection Boot
3	1	End Cap
4	1	Ground sleeve

Tools Required

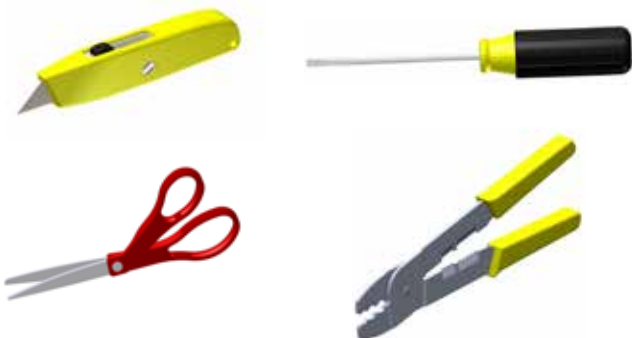

Warnings

- Due to the risk of electrical shock, arcing and fire caused by product damage or improper usage, installation or maintenance, a ground-fault protection device is required.
- Installation must comply with Thermon requirements (including form PN 50207U and form CPD1030 for Ex systems) and be installed in accordance with the regulations as per the norm EN IEC 60079-14 for hazardous areas (where applicable), or any other applicable national and local codes.
- Component approvals and performance ratings are based on the use of Thermon specified parts only.
- De-energize all power sources before opening enclosure.
- Keep ends of heating cable and kit components dry before and during installation.
- Minimum bending radius of heating cable is 32 mm.
- Individuals installing these products are responsible for complying with all applicable safety and health guidelines. Proper Personal Protective Equipment (PPE) should be utilized during installation. Contact Thermon if you have any additional questions.

Certifications/Approvals



International Electrotechnical Commission
IEC Certification Scheme for Explosive Atmospheres
UL 16.0075X



Certificate DEMKO 04 ATEX 136794X
in accordance with the EU ATEX Directive 94/9/EC



Listed De-Icing and Snow Melting Equipment 5N23



Certified Snow Melting Equipment for Applications Having
a Type Designation of 2B

INSTALLATION PROCEDURES

Power Connection Instructions

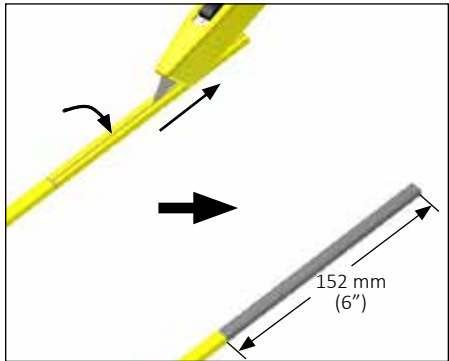

1. Cut and remove heating cable overjacket as shown.

! Do not cut metallic braid.



2. Separate braid strands at edge of overjacket and pull cable through opening in braid.

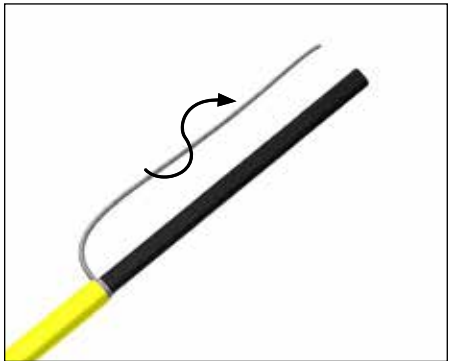

3. Twist braid into a pigtail. Trim ends of braid.

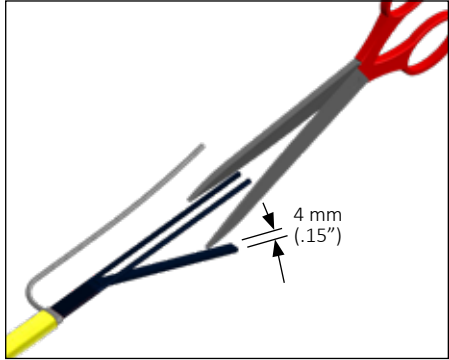

4. Cut a 4 mm strip of conductive matrix between the conductors.

! Do not cut bus wire strands.

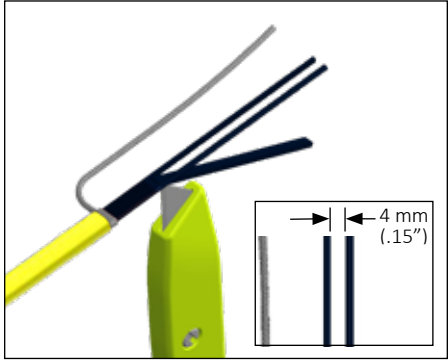

5. Cut and remove the 4 mm matrix strip.

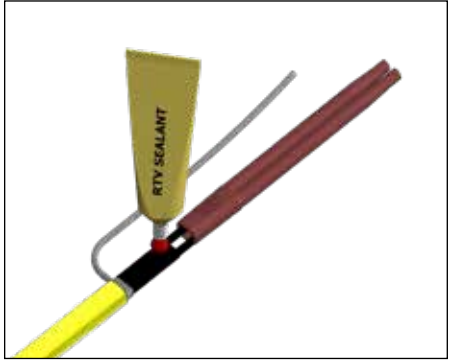

6. Apply RTV sealant to cable to cover distance of at least 3 mm and slide boot onto the end of the cable.

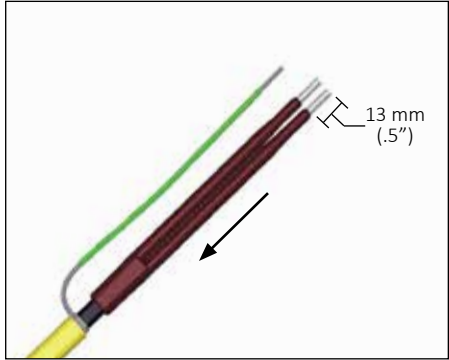

7. Slide boot onto the end of the cable and green ground sleeve over twisted braid. Expose 13 mm (0.5") of bus wire.

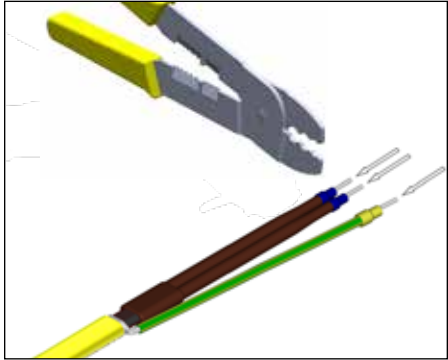

8. Crimp conductor wire pins on each conductor and on twisted braid if required as per client/project specification (order separately).

End Termination Instructions

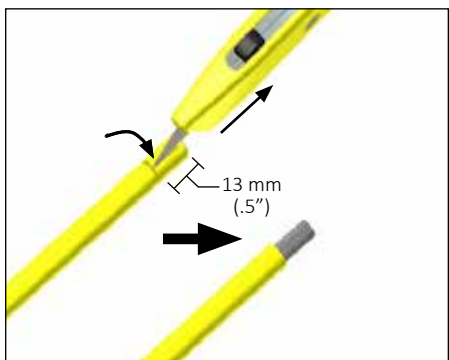

1. Cut and remove heating cable overjacket.

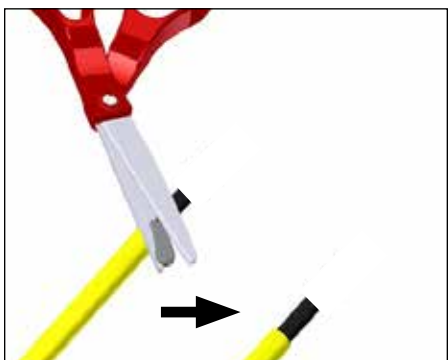

2. Trim away exposed braid from cable.

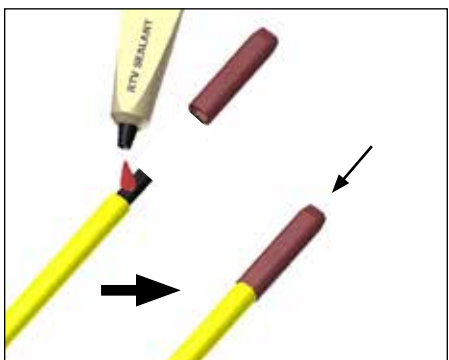

3. Fill the end cap with RTV sealant and apply a circumferential bead to cable [minimum of 3 mm (0.12") wide]. Slide end cap onto end of cable.

Cable Take-Off

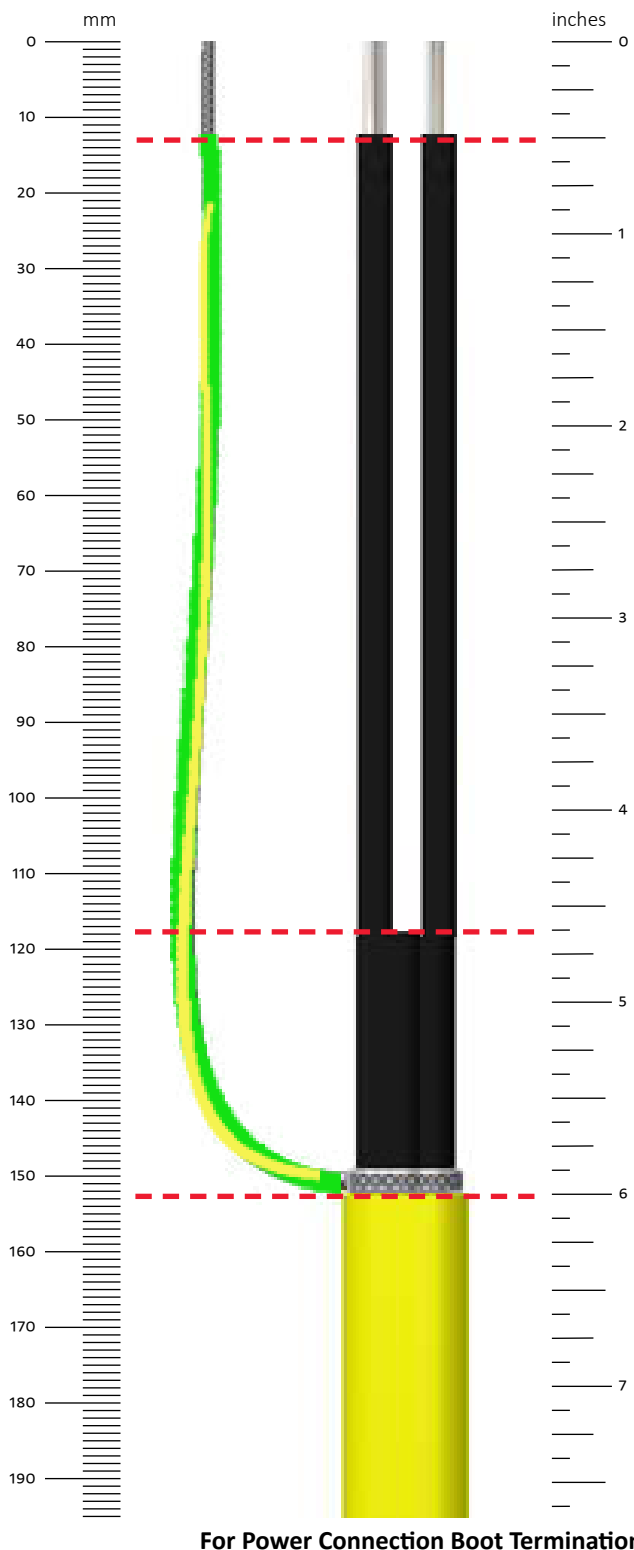

For Power Connection Boot Termination

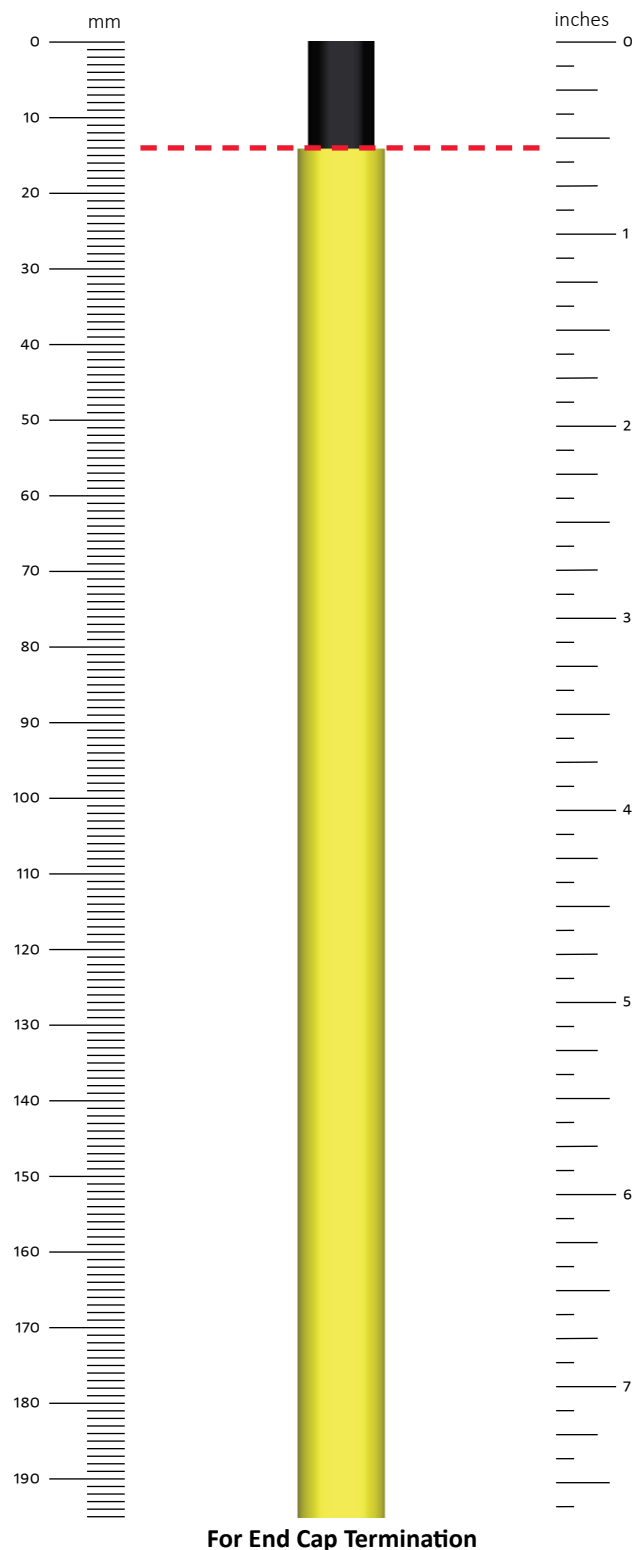

For End Cap Termination

NOTE:
Images may not be printed to scale.



European Headquarters: Boezemweg 25 • PO Box 205 • 2640 AE Pijnacker • The Netherlands • Phone: +31 (0) 15-36 15 370
Corporate Headquarters: 100 Thermon Dr • PO Box 609 San Marcos, TX 78667-0609 • Phone: 512-396-5801 • 1-800-820-4328

For the Thermon office nearest you visit us at . . . www.thermon.com

PN50251U-0917 © Thermon, Inc. • Information subject to change.

