

# TRACENET™ GENESIS

CONTROL AND MONITORING SYSTEM

Installation, Operation & Maintenance Guide



## **TraceNet Genesis Installation, Operation & Maintenance Guide**

This guide, as well as the software and/or firmware described in it, is furnished under license and may only be used or copied in accordance with the terms of such license. The information in this guide is furnished for informational use only, is subject to change without notice, and should not be construed as a commitment by Thermon. Thermon assumes no responsibility or liability for any errors or inaccuracies that may appear in this guide.

This information is subject to change without notice. It is recommended that a quick check of the current revision status be done at [www.thermon.com](http://www.thermon.com) prior to proceeding.

### PRODUCT WARRANTY INFORMATION

The seller warrants all equipment manufactured by it to be free from defects in workmanship or material under normal use and service. If any part of the equipment proves to be defective in workmanship or material and if such part is, within 12 months of the date of shipment from sellers factory, and if the same is found by the seller to be defective in workmanship or material, it will be replaced or repaired, free of charge, F.O.B. the seller's factory. The seller assumes no liability for the use or misuse by the buyer, his employees, or others. A defect within the meaning of this warranty in any part of any piece of equipment shall not, when such part is capable of being renewed, repaired, or replaced, operate to condemn such piece of equipment. This warranty is in lieu of all other warranties (including without limiting the generality of the foregoing warranties of merchantability and fitness for a particular purpose), guarantees, obligations, or liabilities expressed or implied by the seller or its representatives and by statute or rule of the law.

# TraceNet Genesis Installation, Operation & Maintenance Guide

## Table of Contents

Section 1: Genesis Introduction And Overview.....	4
Section 2: Panel Inspection, Field Connections And Internal Wiring.....	4
2.1: Recommended Visual Inspection Procedures .....	4
2.2: Wiring and Connections Survey .....	4
2.3: Control System Operation Check .....	4
2.4: Heat Trace and Insulation Installation.....	5
2.5: Power Distribution Wiring and Breakers.....	5
2.6: TraceNet Panel Wiring.....	5
Section 3: The Genesis System—Overview .....	6
3.1: Genesis Modules Overview.....	6
3.1.1: The HMI Module .....	6
3.1.2: The DCM .....	6
3.1.3: The DTM.....	6
3.1.4: The IOM .....	7
3.1.5: Genesis Modules Address Settings.....	8
3.2: The Genesis HMI Screens.....	9
Section 4: Genesis Control Options and Examples .....	17
4.1: Line Sensing Control.....	17
4.2: Ambient Sensing Options.....	17
4.2.1: Control Method: Proportional.....	18
4.2.2: Control Method: On-Off .....	18
4.3: Control Method: On-Off with Soft Start.....	19
Section 5: Genesis Testing and Start-Up.....	19
Section 6: Operation and Maintenance of the Genesis Control and Monitoring System.....	19
6.1: Maintenance.....	19
6.2: Maintenance Schedule Recommendation.....	20
Appendix A: Quick Start Guide For The Genesis Control And Monitoring System.....	21
Appendix B: Genesis Specifications Guide With Component Limits And Specifications.....	23
Appendix C: Troubleshooting Tips For Reliable Electrical Heat Trace Performance.....	31
Appendix D: Genesis Modbus Memory Reference .....	37
Appendix E: Recommended Wiring For RS 485 Communications.....	38

NOTE: The TraceNet Command Communications Operating Instructions are addressed in a separate document covering TraceNet Genesis, as well as TN, TCM18, TC1818, TCM2, TC202, TC201, TC101, and ECM. TraceNet Genesis requires TraceNet Command Version 2.3.0+ for operation.

## Section 1: Genesis Introduction and Overview

The following serves as a general guide and overview on the installation, startup, operation, and maintenance of a TraceNet Genesis heat tracing control panel. This guide is to be sent in conjunction with the project specific panel drawings and any other installation instructions/guides and standards provided. In the unlikely event that a conflict or uncertainty arises, contact the Thermon engineering support personnel assigned to this project to clarify.

NOTE: All personnel should be properly trained and qualified to safely install, service, operate, and program this TraceNet heat tracing control panel as well as to install, operate, and maintain all associated heat tracing.

## Section 2: Panel Inspection, Field Connections and Internal Wiring

A typical Genesis Panel may include electrical distribution (optional main breaker with branch breakers for each electrical heating circuit, either within the Genesis panel or in an adjacent electrical distribution enclosure. (Refer to the project specific drawings for each panel.)

Wide varieties of TraceNet Genesis panel configurations are possible and can be located in site locations having electrically classified areas and/or ordinary locations. The actual panel markings provided with the panel will detail the approvals for the specific location of the panel.

### 2.1: Recommended Visual Inspection Procedures

- Inspect door and/or solid state heat sink gaskets for water intrusion as indicated by mineral deposits and rust. Where feasible replace any gaskets which appear to be faulty.
- Survey panel exterior and interior for dust, lint, moisture, or foreign residue. Remove any such residue with a lint free cloth material. Heavy residues may be addressed with wood scrapers and a cleaning agent. Do not soak parts with cleaning agent but only use dampened cloths in removing heavy residues. Excessive application of cleaning agents can damage components.
- Check for panel corrosion and scratches. Remove corrosion and prepare any damaged areas with sandpaper. Repaint with the approved primer and touch up paint.
- Check door hinges, latches, and other moving parts for proper operation. Use machine oil to lubricate the moving parts and restore proper operation where necessary.
- Check for mechanical damage to any windows as well as check the window seals. Repair or replace damaged materials. In all cases where equipment damage is observed, a root cause analysis should be initiated to determine any future corrective action needed to prevent a recurrence.

### 2.2: Wiring and Connections Survey

- The wiring and connections survey recommended is as follows:
- If the servicing of removable electrical connectors is to be conducted, then make certain the area is free of explosive atmospheres.
- If equipment is available, an infrared scan of the interior of the panel cabinet and associated wiring (during operation) is recommended.
- Any unusually high temperatures at connections are usually evidence of poor connections. Tighten connections, repair with new terminations, and/or replace any components which have been exposed to long term overheating. All terminal block connections should be tightened using a torque indicating screwdriver to the levels indicated in Table 1 and project installation drawings.
- Check for corrosion at electrical connections and terminations. Where corrosion of electrical terminals is observed, this may be additional evidence of loose connections and excessive heat. A part replacement may be necessary.
- Inspect wiring for abrasion wear, mechanical damage, and thermal overexposure. Repair or replace any damaged or defective wiring. In all cases where equipment damage is observed, a root cause analysis should be initiated to determine any future corrective action needed to prevent a recurrence.

### 2.3: Control System Operation Check

The Genesis controller screen is an ideal resource in facilitating operation checks of the control system. To begin this program, energize the panel and the appropriate heat trace circuits for a minimum of 24 hours or until all circuits are cycling within their appropriate control band. A typical list of operational maintenance checks is available for a successful installation of a TraceNet Genesis heat tracing control and monitoring panel, a number of equally critical parts of the system must be installed properly. Areas requiring close attention are:

- The heat trace and insulation
- The RTD temperature sensor installation
- The distribution of the field RTD and power wiring
- The installation and routing of wiring inside the TraceNet panel.

**Note:** The heat tracing system installation shall be in accordance with the electrical area classification requirements as well as shall conform to the latest requirements as detailed in applicable heat tracing standards, the local Electrical Code and plant standard practices. Where conflicts arise, contact the project engineer for resolution.

## 2.4: Heat Trace and Insulation Installation

All heat trace circuits and insulation shall be installed in accordance with project installation details provided. In addition, refer to the *Electric Heat Tracing Maintenance and Troubleshooting Guide* (Thermon Form No. [20745](#)) for general procedures and installation tips. RTD Installation and Wiring RTD control sensors should generally be installed on the process lines (see figure below) or in ambient (where ambient sensing is applied) in a location that is most representative of the entire heat trace circuit. In general, it is recommended that the sensors not be located at heat sinks such as pipe supports, pumps, and valves as the control system response needs to be based on the majority of the process line.

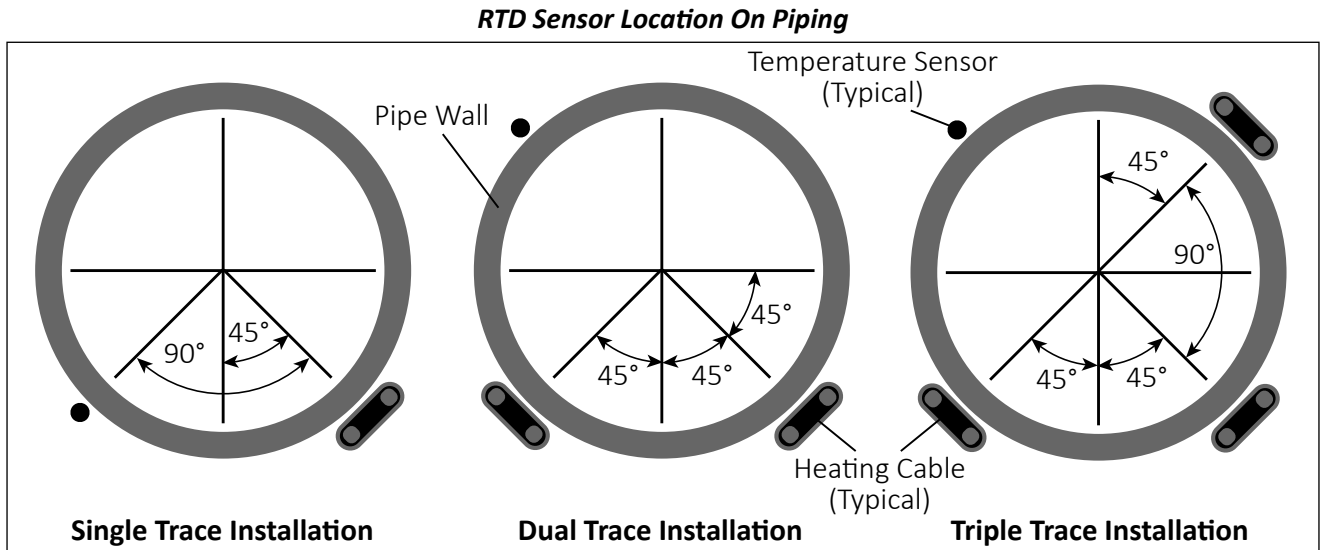

## 2.5: Power Distribution Wiring and Breakers

All field power wiring materials used shall be suitable for the intended service and shall be rated for insulation service temperatures up to and not exceeding 221°F (105°C) unless otherwise higher values are noted in project specifications. Circuit breakers (if not already supplied in the TraceNet panel) should be selected based on the heat trace type being used, the service voltage, and the circuit current draw characteristics. It is especially important when using self-regulating heat trace to make sure that the circuit breaker response curve type is coordinated with the startup characteristic of the heat trace cable in a cold start condition. All distribution wiring connections should be tightened using a torque indicating screwdriver to the levels indicated below.

### Recommended Torque Values (Typical)\*

Solid State Relays on Heat Sink (where used): 12.5–13.5 in. lbs. (1.41–1.53 Nm)

Distribution Equipment: 13.2–15.9 in. lbs. (1.49–1.8 Nm)

\* Required torque values may vary depending on individual panel designs and size of terminals. Refer to project documentation for additional information.

## 2.6: TraceNet Panel Wiring

TraceNet panels are configured and pre-wired into an integrated heat trace control and monitoring system. Clean terminal strips are provided to facilitate the field wiring into the panels. Refer to the project specific panel drawings when installing the field wiring within the panel. All terminal block connections should be tightened using a torque indicating screwdriver to the levels indicated, including terminal block connections to/on TraceNet Genesis modules. All heat trace circuits should be properly terminated and meggered prior to energizing the heat trace power distribution and control panels. In addition, all pipes should be insulated and weather sealed to achieve the expected heat-up and temperature maintenance performance of the system.

## Section 3: The Genesis System—Overview

The TraceNet Genesis system modules include a Human Machine Interface, or **HMI**; at least one (1) Distributed Control Module, or **DCM**; at least one (1) Distributed Temperature Module, or **DTM**; and at least one (1) Input-Output Module, or **IOM**.

### 3.1: Genesis Modules Overview

#### 3.1.1 The HMI Module

The **HMI** (Human Machine Interface) serves as the central monitoring and interrogation point for a TraceNet Genesis control & monitoring system. It allows the operator to access operating control parameters and operating conditions throughout the heat tracing system network. The **HMI** communicates directly with other Genesis modules through CAN bus and Thermon's communication software or external DCS controllers through Ethernet Modbus TCP/IP.



**HMI**

#### 3.1.2: The DCM

The **DCM** (Distributed Control Module) provides 24 Vdc output to solid state and/or mechanical relays. It also provides heater current and earth leakage current measurement for up to six (6) independent heaters/circuits.



**DCM**

Every panel must have at least one (1) **DCM** which can control up to six (6) independent heat trace circuits, each with a unique sub-address from 1 to 6.

#### Configuring the DCM

The **DCM** address(es) are typically set at the factory so that each individual control relay is configured with its designated electrical circuit breaker in the panel as designed and built. If a heating circuit is to be moved to an alternate circuit, it's necessary to have the set points program to the corresponding circuit identified at the HMI (see Section 3.2.6: Circuit Settings).

**DCM With Solid State Relays Mounted On Heat Sink**



**DTM**

#### 3.1.3: The DTM

The **DTM** (Distributed Temperature Module) is DIN rail mountable. Every panel will have at least one (1) **DTM** which can receive inputs from up to six (6) individually identified RTD temperature sensors. The **DTM** has six (6) sub-addresses to distinguish each of up to six (6) individual sensors. Once a DTM module is configured on the panel unique address, any RTD sensor may be mapped to any heater circuit. A single RTD sensor can provide temperature information for an entire Genesis panel. In case of a critical process control an individual EHT circuit can have multiple sensors (up to twenty (20) RTD sensors per heater), and the total number of **DTM** cards per panel can vary by system. Refer to the project specific drawings for each panel.

- For an Ambient Sensing Control Panel, a single RTD sensor can provide input for the entire panel.

- For simplicity it is best to have one (1) RTD sensor per control circuit for Line-Sensing Control, and the number of **DTM's** will match the number of **DCM's**.
- "RTD Mapping" is required to monitor multiple RTD temperature sensors for a common heater. Up to twenty (20) RTD sensors can be assigned to a heated line or surface, in which case there could be more **DTM's** than **DCM's**. The **HMI's** temperature reading display shows control RTD temperature. The lowest temperature is displayed when readings from all RTD's are below the High Alarm set point, and the highest temperature is displayed when any RTD reading exceeds the High alarm set point.

### 3.1.4: The IOM

The **IOM** (Input-Output Module) is a DIN rail mountable input/output module. It's designed to receive inputs and outputs determined by the requirements and design of the system. There will be at least one (1) **IOM** for a Genesis panel to provide system fault and common alarm output.



#### Default I/O Configuration

IOM Sub-address	I/O	Default LED State	Alarm LED State	Function
1	Output	ON	OFF	Common Alarm
2	Output	ON	OFF	Circuit Trips
3	Output	ON	OFF	High Temperature Alarm
4	Output	ON	OFF	Low Temperature Alarm/RTD Fault
5	Input	--	--	Load Shed (Force Off)
6	Input	--	--	Force On
7	Output	ON	OFF	System Fault Alarm

#### IOM Inputs

The inputs on the **IOM** are labeled 5 and 6. Input is switched to ON when an external relay contact is closed. It remains OFF when the external control relay is open.

To use an **IOM** input, wire the appropriate relay as pictured in the diagram.

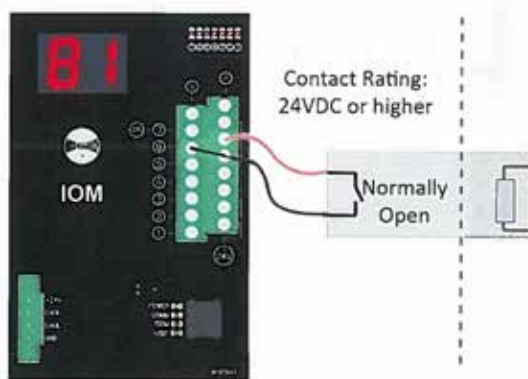

**Load Shed** is programmed to input channel 5. This function allows an external device to control the selected circuits with Load Shed option enabled to turn the heater off. The Load Shed option is found in Circuit Settings. **Warning:** The circuit will switch back to Enable and turn on the heater when the circuit condition is in Low Temperature Alarm.

**Force On** is programmed to input channel 6. This function allows an external device to control the selected circuits with Force On option enabled to override other settings and turn the heater on. The Force On option is found in Circuit Settings. **Warning:** The circuit will switch back to Enable and turn off the heater when the circuit condition is in High Temperature Alarm.

#### IOM Outputs

The outputs on the **IOM** are labelled 1-4 plus 7. Output 7, (SYS), is a non-configurable output for system fault alarm.

To use an **IOM** output, wire the appropriate relay as pictured in the diagram. Each output is designed to drive an interposing relay  $\leq 24$  Vdc with  $< 100$  mA for local or remote alarms. (For specific ratings, consider a Phoenix PLC-RSC-24DC/2 I/EX, or equal.)

**The IOM input/output channels function are fixed and not configurable.**

### 3.1.5: Genesis Modules Address Settings

The Genesis **DCM** (Distributed Control Module), **DTM** (Distributed Temperature Module), and **IOM** (Input Output Module) each have a two-digit address code. The two (2) digit code used to identify each module through the CAN bus to the **HMI** (Human Machine Interface). The **HMI** does not have a two (2)-digit code.

There are ninety-nine (99) addresses available for Genesis modules: 01 through 99. (Note that “00” is not a valid code). No two modules within a panel can share the same code. Each of the Genesis Modules is addressed separately below.

**Note 1:** While modules can be uniquely identified to any address, it is highly recommended to start module addressing according to the table provided in sequential order, followed by **DTM's** with the **IOM** being the last address assigned.

**Note 2:** At minimum one of the module placing at the end of the CAN bus line must has terminator enable. Normally those are the modules that do not have cable split at the CAN bus connector. To enable terminator, press and hold the button on the specific **DCM**, **DTM**, and/or **IOM** until “En” (meaning Enable) flashes. Then release and toggle again to change from OFF to ON. The set value will remain for 5 seconds then returns to show node ID address. When the terminator set to ON the terminator LED indicator will light up.

Module	CAN Address
DCM	1-20
DTM	21-80
IOM	81
HMI	Blank

The addresses of the installed **DCM**, **DTM** and/or **IOM's** are generally set at the panel shop by properly trained Genesis technicians to match the panel design so that each circuit is aligned with the assigned **DCM** and **DTM**. If special circumstances require changing the address of a module, they can be manually reconfigured by pressing and holding the button until the address flashes. Pushing the button again before the five seconds have passed will restore the previous setting. The new address will flash for five seconds after which the new address will be set.





### 3.2 The Genesis HMI Screens

The following section details configuration of the TraceNet Genesis **HMI** module.

#### 3.2.1: Circuit Overview

Provides a quick status of all circuits at a glance while highlighting one circuit a time with more detail. Each dot around the perimeter of the selector dial represents one circuit. Circuit 1 is at the top of the dial and circuit numbers ascend clockwise around the dial.

- Red dots represent circuits in active alarm.
- Yellow dots represent circuits with acknowledged alarm.
- Green dots represent enabled circuits with no alarms present.
- Grey dots represent disabled circuits.

To move between circuits, touch the circuit dot, drag the black selector around the dial or use the arrows on either side of the circuit

number. The center of the dial displays the highlighted circuit's live temperature, maintain temperature, circuit name, and on-off duty cycle. Touch anywhere inside the dial to enter that circuit's dashboard.

A slightly different view for circuits set for ambient control emphasizes electrical current (amps) measurement versus present temperature. To change the display to show ambient control, the assigned ambient RTD must also be identified through the RTD list in Global Settings.



**Note:** Temperature shown for line sensing control method.

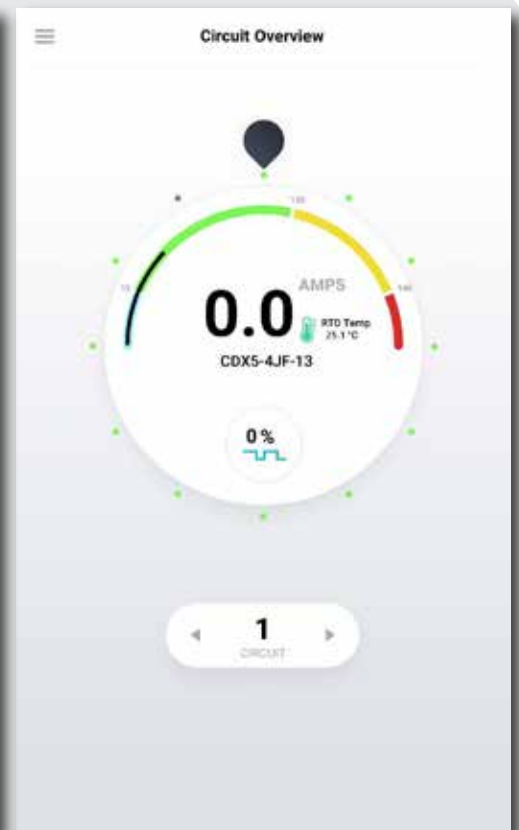

**Note:** Operating current shown for ambient sensing control method.

### 3.2.2: Main Menu

To access the Main Menu, touch the 'hamburger' icon in the upper left corner of any screen. Use the Menu to navigate between Overview, Circuit List, Global Settings and the System screen as well as to switch between night and day color profiles and to Import and Export configurations, isometrics, etc.

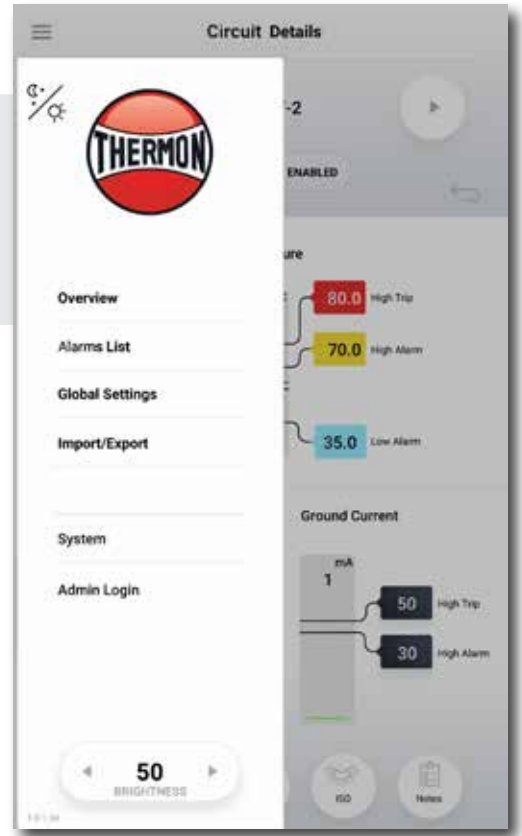

### 3.2.3: Admin Login

The user will be prompted to log in as an administrator when attempting to change any setting or set-point or Admin Login may be selected from the Menu. Admin mode is indicated by the red tint and red border on and around all screens. The system will remain in Admin Mode for 5 minutes after a valid password entry, even if actively programming circuits.

**Note:** The *initial* "Admin Login" value is "abc123" (it is *not* case-sensitive). The "Admin Login" should be assigned to the responsible Project Manager or Administrator with the authority over process unit(s) where this panel is installed. This information should be secured but accessible in the event of an emergency.

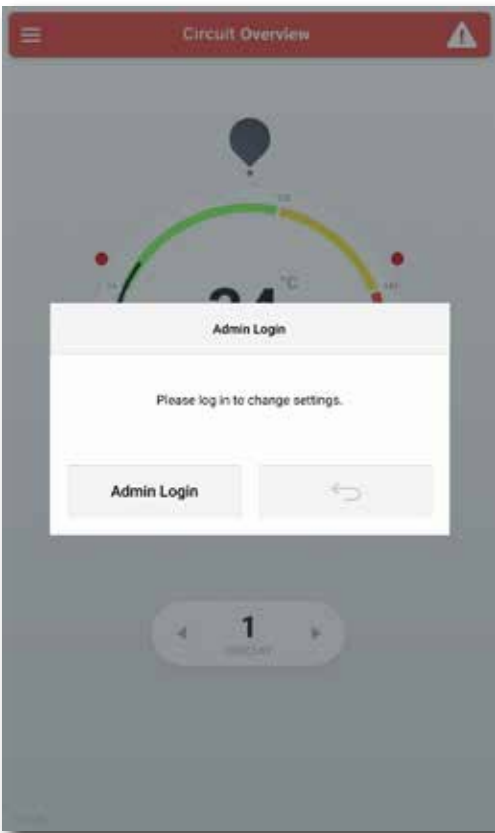

### 3.2.4: Global Settings

Global Settings can be reached from the Menu. These settings such as Temperature Units and Start-up Delay apply to the system as a whole.

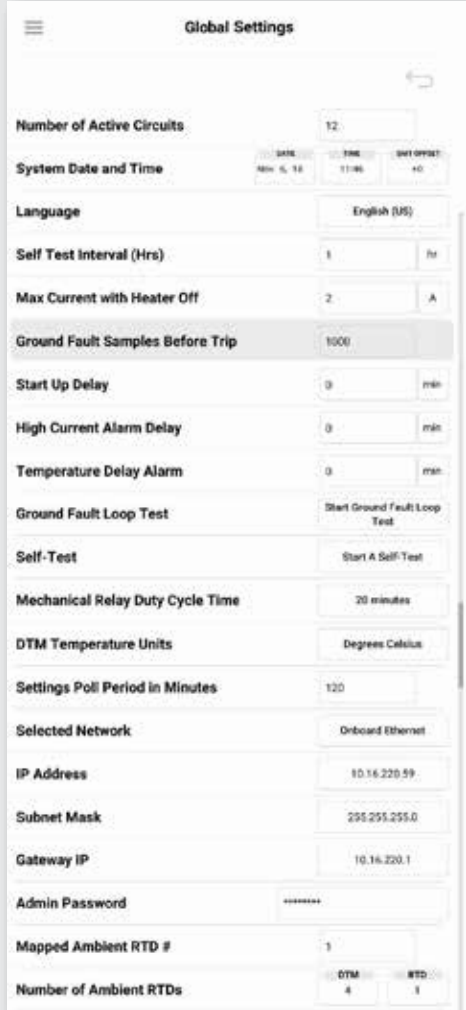

Setting	Description	Acceptable	Lower Limit	Upper Limit	Units
System Date and Time	Current Time and Date	Gregorian Calendar; 24 hr time; time zone offset from GMT			
Language	Displayed system language	English (US), English (UK), Arabic, Chinese, Spanish, French, Japanese, Korean, Russian			
Self Test Interval (Hrs)	Time in hours between automatically run self tests	Number	0	168	Hours
Max Current with Heater Off	Maximum current reading allowed when a heater is off before a circuit fault alarm is triggered	Number	0.5	5	A
Ground Fault Samples Before Trip	Number of ground current samples read above trip set point before trip is triggered. (does not affect time to trip because the samples are microseconds apart) This is to improve noise immunity.	Number	0	6	
Start Up Delay	Time in minutes before heaters turn on for the first time after system power up. This allows users to stagger start up across many panels to reduce load step on plant power.	Number	0	30	Minutes
High Current Alarm Delay	Time in minutes to delay current alarms after high readings. This is to prevent nuisance alarms on startup current.	Number	0	7	Minutes
Temperature Delay Alarm	Time in minutes to delay temperature alarms. This is useful for avoiding nuisance alarms due to steam-out.	Number	0	30	Minutes
Ground Fault Loop Test	Runs self contained test to confirm integrity of the ground current measurement system.	Touch to Start			
Self-Test	Runs self contained test including the ground fault loop test and additionally turns measures heater current with heater on and off to verify relay operation and current measurements.	Touch to Start			
Mechanical Relay Duty Cycle Time	Duty cycle period for relays in proportional control mode.	20 Minutes			Minutes
DTM Temperature Units	Switch temperature units between Fahrenheit and Celsius	Fahrenheit, Celsius			
Settings Poll Period in Minutes	Time in minutes between requests from HMI to modules for all system information	Number	5	20	Minutes
Selected Network	Switch between Onboard Ethernet (default) or USB (for use with USB-Ethernet adapter- diagnostics)	Onboard/USB			
IP Address	Internet Protocol Address (see network administrator for IP Address assignments)	IPv4 Address	0.0.0.0	255.255.255.255	
Subnet Mask	Binary mask which defines the subnetwork to which a device belongs (see network administrator for Subnet Mask assignments)		0.0.0.0	255.255.255.255	
Gateway IP	First networking device connected to on the network (see network administrator for Gateway IP assignments)	IPv4 Address	0.0.0.0	255.255.255.255	
Admin Password	Password used to protect the system from unintended or unauthorized changes	Alpha-numeric 50 character limit			
Number of Ambient RTDs	Sets the number of ambient RTD sensors used by the system	Number	0	6	
Mapped Ambient RTD#	Address and Subaddress of the assigned RTD; the number of "Mapped Ambient RTD#" fields corresponds to the "Number of Ambient RTDs" value, i.e. if "Number of Ambient RTDs" is set to 3, there will be 3 "Mapped Ambient RTD#" fields to provide an address for each RTD	DTM: number 1-99; RTD: Number 1-6			

### 3.2.5: Dashboard/Circuit Details

The dashboard provides a comprehensive single circuit view. It includes the circuit number, tag, pipeline number, or other status as well as real-time temperature, heater current, ground leakage current and related alarm set points. This screen can be reached by tapping a circuit in the Overview or the Circuit List. The limits below define the lowest and highest possible values. (The bounds define the constraints for valid values, e.g. maintain temperature should not be set below the low temperature alarm.)

#### Circuit Alarms

In the event that the measured conditions of the heat trace circuit fall outside the user-defined parameters, the Genesis will notify the user. When an alarm condition first occurs, the common alarm digital output will annunciate and a message will appear on the Circuit Screen to inform the user of the type of alarm present. Pressing will acknowledge the alarm and deactivate the digital output. Alarms will automatically clear when the alarm condition is no longer present.

#### Circuit Trips

In the event that the measured conditions of the heat trace circuit go beyond the TRIP settings of the circuit, the circuit will trip, i.e. turn off. When a circuit trips, the circuit will be deactivated and a corresponding message will be displayed. (A TRIP event is different from an ALARM event in that the heat trace circuit is deactivated and will remain deactivated until the circuit is manually reset by the user.)



**Note:** In general, the alarm will not clear until the measured conditions of the heat trace circuit fall within the user-defined parameters. For instance, a low current alarm will not clear simply because a circuit heater is de-energized (i.e. no longer calling for heat). It will remain active until the measured current value is confirmed to be above the low current set point, (i.e. on the next heating cycle when the heater is energized).

The line below the circuit name will indicate any alarm(s) present. Where multiple alarm events occur on a circuit, the line will display only one alarm message at a time until all have been cleared. A summary of all possible alarm messages follows.

#### Message Explanation

##### RTD FAULT ALARM

The RTD reading is out of the range when the resistance value exceeds 313.7 Ohms or is less than 48.46 Ohms. In this case, either the RTD has not been connected or has opened or shorted in service.

##### LOW TEMP ALARM

The temperature being read on this circuit is below the value programmed as the lowest temperature allowed before an alarm condition should be reported. The low temp alarm will automatically clear when the low temperature condition clears.

##### HIGH TEMP ALARM

The temperature being read on this circuit is above the value programmed as the highest temperature allowed before an alarm condition should be reported. The high temp alarm will automatically clear when the high temperature condition clears.

##### HIGH-HIGH TEMP (OPTION TRIP)

The temperature being read on this circuit is above the value programmed as the highest temperature allowed before a High-High condition is reported. When the temperature trip is enabled and a temperature exceeds the TRIP level, the event must be acknowledged, and the temperature level must drop below the TRIP set point value before the circuit will re-energize. Once the alarm is acknowledged the alarm color message will change from Red to Orange. When the trip is not enabled, trip temp alarm will automatically clear when the reading returns to normal condition.

##### Ground Current HIGH ALARM

The ground/earth leakage current being read on this heater (and associated wiring) circuit is above the value programmed as the highest leakage current allowed before an alarm event is reported. The ground/earth current alarm setting will automatically clear when the high ground/earth current alarm event clears.

##### Ground Current HIGH-HIGH ALARM (OPTION TRIP)

The ground/earth leakage current being read on this circuit (and associated wiring) is above the value programmed as the highest heater leakage current allowed before a TRIP event is reported. When the ground/earth leakage current exceeds the TRIP level, the condition must be acknowledged, and the leakage current level must drop below the TRIP set point value before the circuit will re-energize.

##### LOW Current ALARM

The amperage being read on this circuit is below the value programmed as the lowest heater operating current allowed before an alarm condition is reported. This event is reported as a LOW Current ALARM.

## HIGH Current ALARM

The amperage being read on this circuit is above the value programmed as the highest heater operating current allowed before an alarm condition is reported. The current alarm will automatically clear when the high heater current alarm event clears. This event is reported as a HIGH Current ALARM.

## HIGH-HIGH Current (OPTION TRIP)

The current being read on this circuit is above the value programmed as the highest current allowed before a TRIP condition is reported. When the current trip is enabled and a reading exceeds the TRIP level, the event must be acknowledged, and the current level must drop below the TRIP set point value before the circuit will re-energize. Once the alarm is acknowledged the alarm color message will change from red to orange. When the trip is not enabled, trip current alarm will automatically clear when the reading returns to normal condition.

## Circuit FAULT ALARM

There are three possibilities could cause a circuit fault condition.

- CAN bus communication interruption
- DCM board is damaged.
- During the SELF-TEST procedure, it is determined that the heater current does not change between the ON and OFF states.

## Ground FAULT ALARM

A ground fault condition is reported if during a TEST-TO-TRIP procedure of applying a test leakage current to each circuit, it is determined that the test leakage current is not sensed.

## Programming Error

This warning message appears when the values that have been programmed for temperature, current, and/or ground current are in conflict. The programmed values are to be set as follows:

$$\text{Low Alarm} < \text{Maintain Set point} < \text{High Alarm} \leq \text{High-High Alarm (Trip optional)}$$

**Warning:** It is possible that a heating circuit may turn on even if a programming error exists. For example, the Maintain SP is set above the High Alarm. The circuit will display programming error, but as soon as the actual temperature is below the Maintain SP the circuit heater will turn on. (For line-sensing control the solution is to ensure the High Temp Alarm set point is above the Maintain SP plus control band.)

Set-point	Description	Available Options	Lower Limit	Lower Bound	Upper Bound	Upper Limit	Units
<b>Circuit Information</b>							
Circuit Number	Number of the circuit within the panel	Read-Only	1			72	None
Circuit Tag	Alpha-numeric Identifier	Read-only in Dashboard, User-defined in Settings				50	Characters
Circuit Status	Percent On (Duty-Cycle); Enable Button	Disabled, Enabled, Enabled Forced-On, Enabled Forced-Off				100	%
<b>Temperature</b>							
High High Alarm/High Temp Trip <sub>1</sub>	High High Alarm: If Temperature Trip is disabled. High Trip: If Temperature Trip is enabled	User-Defined	-200 (-328)	High Temperature Alarm Set Point	Upper Limit	650 (1200)	°C (°F)
High Temp Alarm <sub>2</sub>	High Temperature Alarm activates at and above this set point	User-Defined	-200 (-328)	Max + 1	High High Alarm/High Trip Set point	650 (1200)	°C (°F)
Max	Above Max heater duty cycle is 0%, i.e. Heater is off	User-Defined	1	1	High Alarm set point-Maintain set point- 1	650 (1200)	°C (°F)
Temperature	Real-time Temperature measurement	Read-only Measurement	-200 (-328)			650 (1200)	°C (°F)
Maintain	Set point at and below which heater duty cycle is 100%	User-Defined	-200 (-328)	Low Alarm set point + 1	Max- 1	650 (1200)	°C (°F)
Low Alarm <sub>3</sub>	Low Temperature Alarm activates at and below this set point	User-Defined	-200 (-328)	Lower Limit	Maintain Temperature- 1	650 (1200)	°C (°F)
<b>Notes:</b>							
1. HIGH TEMP TRIP (HIGH HIGH TEMP) If HIGH TEMPERATURE TRIP is ON (OFF), this message will be displayed if the measured temperature rises above a value equal to the HIGH TEMPERATURE TRIP (HIGH) set-point.							
2. HIGH TEMP ALARM The measured temperature has risen above a value equal to the HIGH TEMPERATURE ALARM set-point but has not yet risen above a value equal to the HIGH TEMPERATURE TRIP/HIGH set-point.							
3. LOW TEMP ALARM The measured temperature has fallen below a value equal to the LOW TEMPERATURE ALARM set-point.							
<b>Heater Current</b>							
High High Alarm/High Current Trip <sub>4</sub>	High High Alarm: If Current Trip is disabled. High Trip: If Current Trip is enabled	User-Defined	0	High Alarm	Upper Limit	100	A
High Current Alarm <sub>5</sub>	High Current Alarm activates at and above this set point	User-Defined	0	Low Alarm + 1	High High Alarm/High Trip	100	A
Low Current Alarm <sub>6</sub>	Low Current Alarm activates at and below this set point	User-Defined	0		High Alarm set point- 1	100	A
<b>Notes:</b>							
4. HIGH CURRENT TRIP (HIGH HIGH AMPS) If HIGH CURRENT TRIP is ON (OFF), this message will be displayed if the measured heater current is higher than the HIGH CURRENT TRIP (HIGH) set-point.							
5. HIGH CURRENT ALARM The measured heater current rise is higher than the HIGH CURRENT ALARM set-point but not above the HIGH CURRENT TRIP/HIGH.							
6. LOW CURRENT ALARM The measured heater current has fallen lower than the LOW CURRENT ALARM set-point.							
<b>Ground Current</b>							
High High Alarm/High Leakage Trip <sub>7</sub>	High High Alarm: If Ground Trip is disabled. High Trip: If Ground Trip is enabled	User-Defined	20	High Alarm	Upper Limit	255	mA
High Leakage Alarm <sub>8</sub>	High Ground Fault Current Alarm activates at and above this set point	User-Defined	20	Lower Limit	High High Alarm/High Trip	255	mA
<b>Notes:</b>							
7. HIGH LEAKAGE TRIP (HIGH HIGH GROUND) If GROUND CURRENT TRIP is ON (OFF), this message will be displayed if the measured ground/earth leakage current rises above the GROUND CURRENT TRIP (HIGH) set-point.							
8. HIGH LEAKAGE ALARM The measured ground/earth leakage current has risen above the GROUND CURRENT ALARM set-point but not above the GROUND CURRENT TRIP/ALARM2 set-point.							

### 3.2.6: Circuit Settings

Settings **on a per circuit basis** (distinct from set points) can be found here. This includes things like trip enabling assignments with number and address of RTDs.

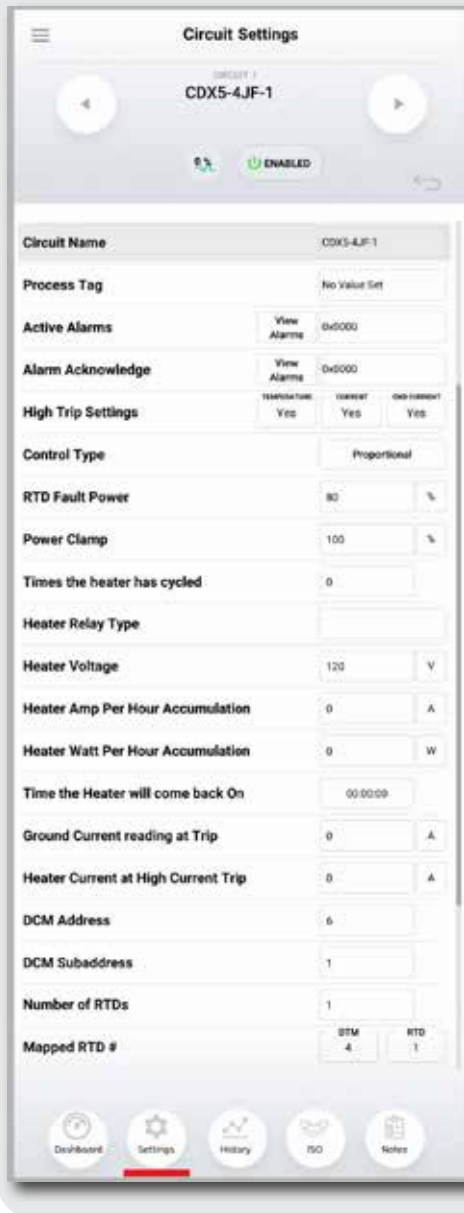

Setting	Description	Available Options	Lower Limit	Upper Limit	Units
Circuit Name	User defined Alpha-numeric Identifier unique to circuit	Alpha-numeric, Upper/Lower Case, hyphen, dot	1	50	Characters
Process Tag	User defined alpha-numeric				
Identifier For Grouping Circuits Together By Associated Process	Alpha-numeric, Upper/Lower Case, hyphen, dot	1		Characters	
Active Alarm	Hexadecimal code for active alarms and a button to display and acknowledge active alarms	Acknowledge individual alarms or acknowledge all alarms	0x0000	0xFFFF	
Alarm Acknowledge	Hexadecimal code for active alarms and a button to display and acknowledge active alarms	Acknowledge individual alarms or acknowledge all alarms • When all alarms are acknowledged the alarm relay will reset regardless of the alarm condition	0x0000	0xFFFF	
High Trip Settings	Enable or disable buttons for Temperature, Current and Ground Current trips	Enable/Disable • When a trip is enabled the alarm must be acknowledged to reset the circuit			
Control Type	Chose control method for circuit	On/Off, On/Off with Soft-Start, Proportional, Ambient Proportional Control			
RTD Fault <sub>9</sub>	Chose the forced duty cycle in the event of an RTD Fault	Number	0	100	%
Power Clamp <sub>10</sub>	Maximum duty cycle allowed on circuit • Does not apply for Mechanical Relay	Number	0	100	%
Times The Heater Has Cycled <sub>11</sub>	Cycle count for mechanical relay controlled by circuit	Number; read-only	0	2,147,483,648	Since Commissioning
Heater Relay Type	Displays mechanical or solid-state relays	Mechanical/SSR		Fixed at panel shop	
Heater Voltage <sub>12</sub>	Voltage provided to trace heater from relay(s)	Number	0	Fixed at panel shop	Volts
Heater Amp Hour Accumulation	Running total of Amp Hours accumulated since last reset of value	Number	0	2,147,483,648	
Heater Watt Hour Accumulation <sub>13</sub>	Running total of Watts accumulated since last reset of value	Number	0	2,147,483,648	Watts
Time Heater Will Come Back On	Applies to APCM; time left until the heater switches on again within 20 minute window	Number	0	20	Minutes
Ground Current Reading At Trip	Ground fault current reading that caused most recent trip	Number	20	255	mA
Heater Current Reading At High Current Trip	Heater current reading that caused most recent trip	Number	1	100	A
DCM Address	Address (displayed on each board) unique to each board that allows communication between modules	Fixed number between 01-20	1	Fixed at panel shop	

**Notes:**

9. RTD FAULT ALARM An RTD reading is out of range when the resistance exceeds 313 Ω or is less than 48 Ω. In either case, the RTD has been damaged or has been disconnected in service. NOTE: The Genesis will continue to control if a second undamaged RTD is available. Otherwise, the default heater status is "De-energized".
10. "Power Clamp" for Genesis Systems are available when the units are used with solid-state relays, and is enabled when a circuit is set for "on/off with soft start". This feature literally provides "soft start" using a reduced on/off duty time cycle of 1 second initiating at the percentage selected.
  - Example 1: Power Clamp of 20% is selected this results in an initial duty cycle of 0.2s "full on" and 0.8s off)
  - Example 2: "on/off with soft start" is selected with 100% Power Clamp. The result is that the circuit will operate in a normal on/off method.
11. This value can be reset with the Admin login after replacing relays.
12. The heat/voltage value is not measured by the Genesis system. This value is fixed before panel shipment to match design and distribution voltage as constructed.
13. This value is calculated from supplied voltage and measured heater current.

### 3.2.7: Circuit History

Plots up to six months of temperature and current data with accompanying set point changes.

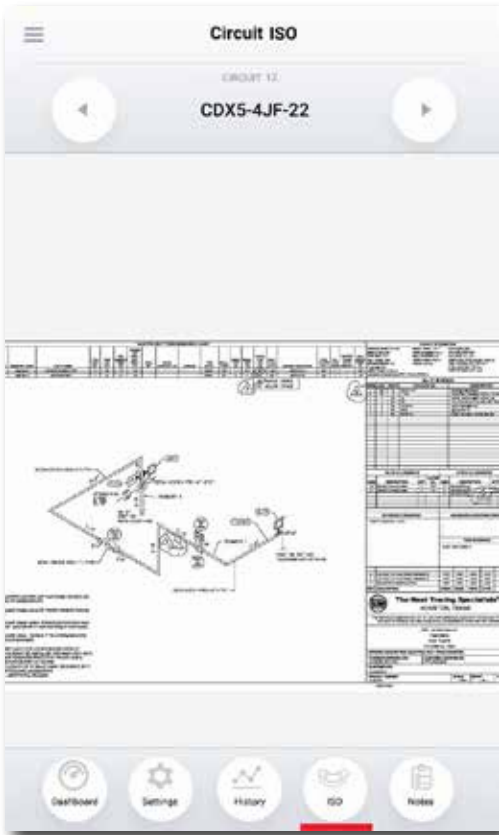

### 3.2.8: Circuit ISO

Use multi-touch pinch and zoom gestures to view the ISO (isometric drawing) for the circuit.

### 3.2.9: Circuit Notes

Useful notes can be stored here for any purpose such as for operators across shifts or for maintenance (requires log-in).

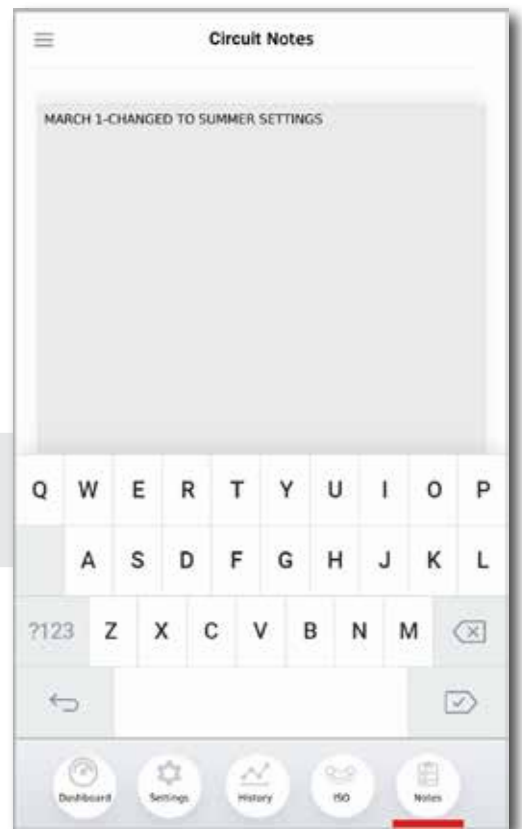

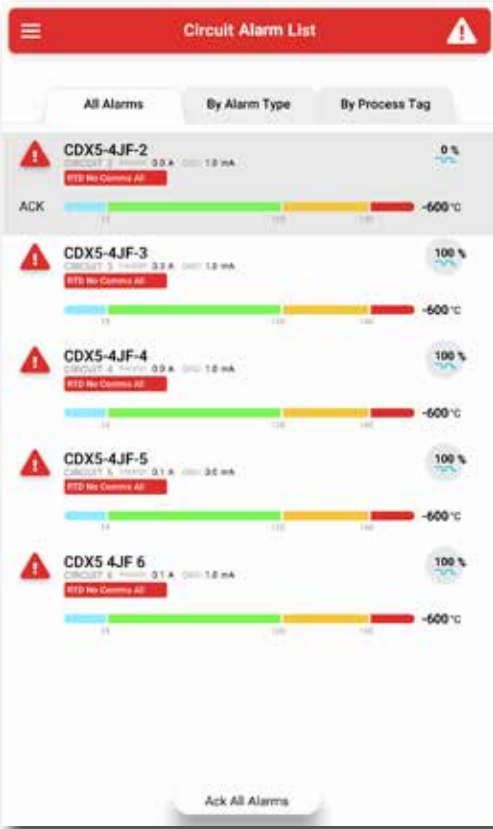

### 3.2.11: Circuit Alarm List

The Circuit Alarm List can be reached from the Menu. Here, live panes for each circuit in alarm, appear in a list organized with tabs for all alarms, by alarm type or by process. To acknowledge an alarm, tap Ack on the left of the circuit pane. A box will appear displaying each alarm for that circuit. Any individual alarm or all alarms for that circuit can be acknowledged.

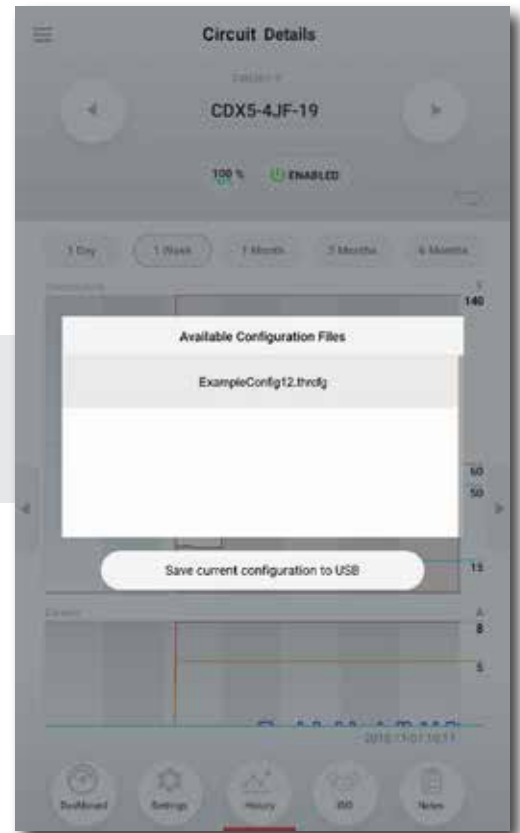

### 3.2.12: Import/Export

The Import/Export feature is used to load system configuration files to easily and quickly set up an entire panel. (Import/Export is via USB port on the back of the HMI.)

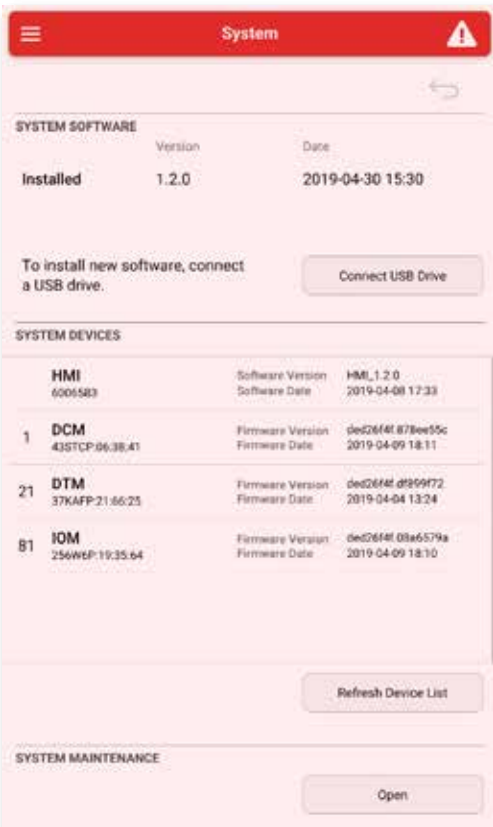

### 3.2.13: System

Provides a means of updating system software and firmware. Shows the current installed version. Use the *Mount USB Drive* button to show a list of all Genesis modules, including address and firmware versions. Requires Admin Login for access.



## Section 4: Genesis Control Options and Examples

The TraceNet system allows different options for heat trace control.

- Line sensing (RTD Sensor on pipe-wall and requires consideration of process flow.)

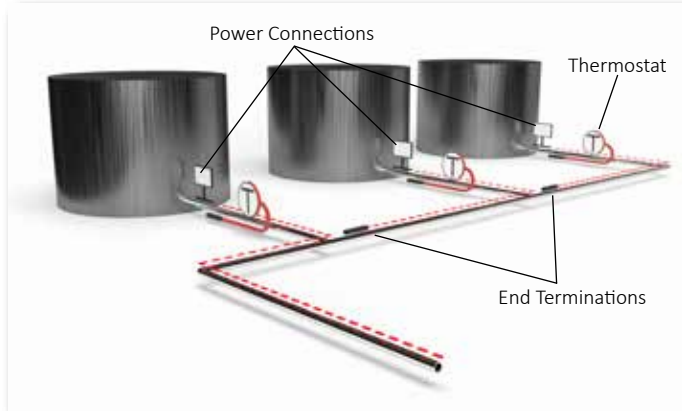

**Line Sensing Control** considering possible flow paths

- Ambient Sensing (“On-off” or Ambient Proportional Control)

The most energy efficient control mode is to use one (or more) line sensing RTD’s for each heat trace circuit.

For winterization, ambient sensing is the most common because it represents the fewest electrical circuits and lowest installed cost. See Figure 2, below.) It is also the least accurate method of control; all connected heaters are energized when the ambient temperature falls below the control set-point.

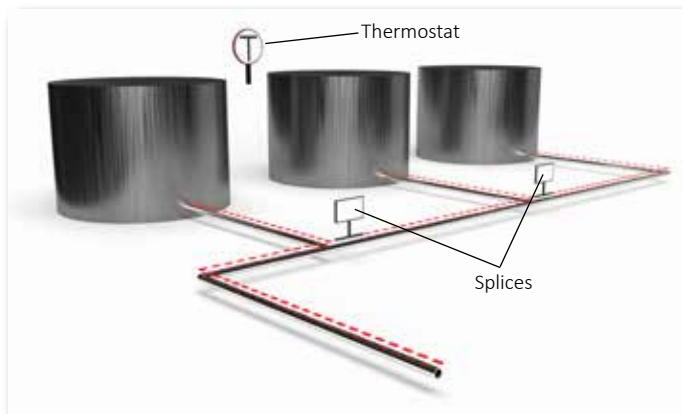

**Ambient Sensing Control** without concern for flow path

- Ambient “On-off” control delivers 100% power whenever energized, the least energy efficient.
- Ambient Proportional Control (APC with Solid State Relays, or APC-M with Mechanical Relays) delivers a percentage of power determined by the difference between the desired maintain temperature and the measured ambient temperature at any time. (More energy efficient than Ambient “On-Off”, but not as efficient as line sensing.)

### 4.1: Line Sensing Control

When the RTD is directly sensing pipe-wall surface for control, the key parameters are “Maintain Temperature”

at which the heat trace is energized or turned on. The “Max” temp setting is where the heat trace will be de-energized, or turned off. The difference between these control settings defines the “Control band” (aka “control differential” or dead-band )

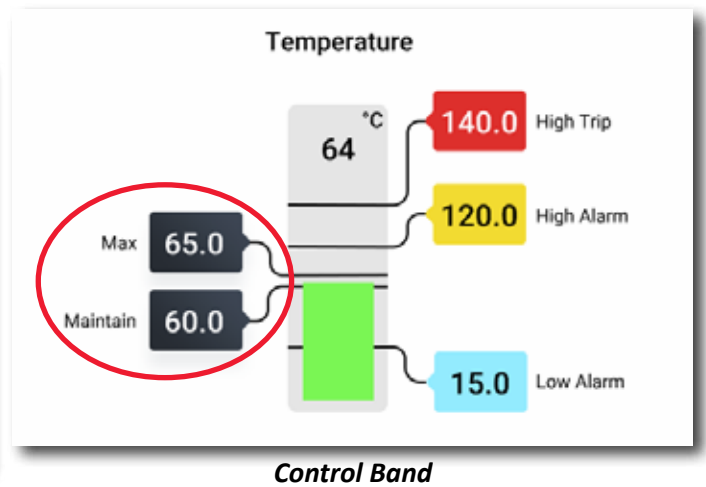

The line sensing RTD(s) temperature is read by the Genesis for heater control for low and high temperature alarms. (A “high-high” temperature setting with circuit “trip” option is also determined from the line sensing RTD(s).) When configured with more than one RTD sensor, TraceNet Genesis displays and controls from the lowest temperature RTD reading, and alarms are triggered from the highest.

### 4.2: Ambient Sensing Options

For the TraceNet Genesis system, (and its predecessor the TCM18), “Ambient Proportional Control” or APC, refers to a “time proportioning” function for saving energy when compared to Ambient Sensing “On-Off” temperature control. As an example, if a given situation calls for 50% power, then the controller cycles on and off 50% of the time to achieve this energy delivery.

APC mode is less energy efficient than line-sensing control, but generally allows fewer heating circuits and longer circuit lengths.

Ambient Proportional Control can be successfully used for maintaining elevated process temperatures as well. This can reduce the number of heating circuits by allowing longer heating circuits, but will not be as energy efficient as line-sensing RTD temperature control .

The APC method has traditionally utilized solid state control relays capable of rapid cycling during operation. By expanding the cycle time to 20 minutes between “on” and “off”, however, mechanical relays can be used. This is referred to as APC-M.

### Heater Relay Type

Control relays for TraceNet Genesis can be either solid state or mechanical switching relays. The TraceNet Genesis control output is a nominal DC voltage of 24 Vdc to drive the solid state or mechanical relays. There are advantages and limitations of both relay types. Consult your Thermon service provider if you have questions.

#### 4.2.1: Control Method: Proportional

Proportional Control can operate with either Solid State Relay (SSR) or Mechanical Relay (MR). The heat trace will be set to operate at 100% power (continuously on) at the minimum ambient for APC or APC-M. It will operate at the maintain temperature for Line Sensing Control, reducing power delivered as the RTD temperature rises above the maintain temperature, at which point the power delivered will be 0%. This "Proportional Control" is achieved by cycling the power to the heat trace "on" and "off" proportionally to the difference between the "Maintain" and RTD temperatures. (Note: Before switching off, the minimum power delivery is 8%, so that the electrical current and earth leakage current levels can be accurately measured.)

The switching on/off cycle for mechanical relays is fixed at 20 minutes. The time remaining before the heater will be re-energized is displayed under "Circuit Configuration" as the next heat on cycle.

##### Example of Ambient Proportional Control (APC):

To maintain +40°F (+5°C) (i.e. to keep water from freezing) in a minimum ambient condition of -40°F (-40°C) with APC control method, follow this procedure:

The "Maintain" Temperature is set at +40°F (+5°C), above which the heat trace would be de-energized, or "Off".

The "Minimum Ambient" temperature (at which power is on 100%) is programmed to be -40°F (-40°C).

(Note: the difference between the Maintain and the Minimum Ambient temperature defines the "Control Band" (aka "Control differential" or "dead band"), across which the time "on" and "off" is established to deliver the heat proportionally. The reduced power delivery results in overall energy consumption when compared to Ambient "On-Off" Control.)

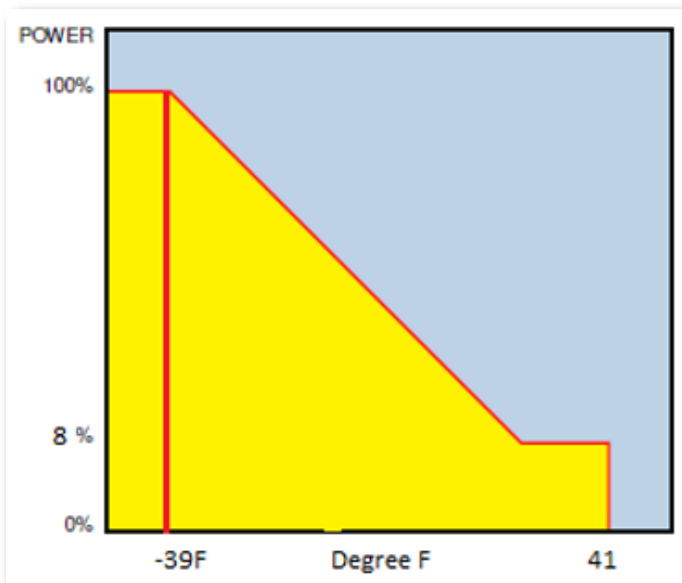

**Ambient Proportional Control** with 100% Power at the minimum ambient setting of -40°

##### Example of Ambient Proportional Control with Mechanical Relays (APC-M):

Maintain +40°F (+5°C) (i.e. to keep water from freezing) in a minimum ambient condition of -40°F (-40°C) with APC control method, follow this procedure:

The "Maintain" Temperature is set at +40°F (+5°C), at which the heat trace would be de-energized, or "Off".

The "Minimum Ambient" temperature (at which power is on 100%) would be programmed to be a value of -40°F (-40°C).

In this example, assume the reading temperature is at 0°F (-17°C).

$$\% \text{ Temperature} = (\text{Maintain Ambient} - \text{RTD Temperature}) / (\text{Temperature Span}) * 100\%$$

$$\% \text{ Power} = (40 - 0) / (80) * 100\% = 50\%$$

Heater On-Off Cycle is fixed at 20min, so 50% power would represent 10 minutes "on" and 10 minutes "off"

(Note that the difference between the Maximum and the Maintain Ambient temperature defines the "Control Band", across which the time "on" and "off" is established to deliver the heat proportionally. The reduced power delivery results in overall energy consumption when compared to Ambient "On-Off" Control.)

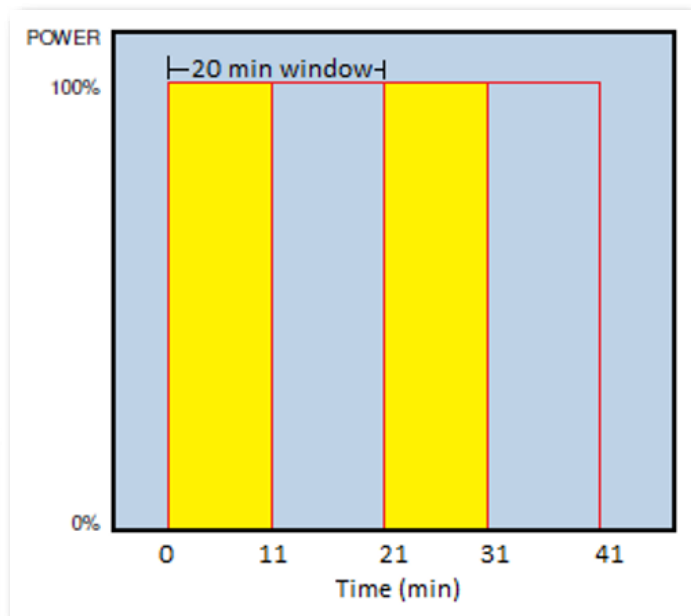

**APCM** when ambient temperature calls for 50% of power for desired Maintain Temperature

#### 4.2.2: Control Method: On-Off

In this case the heat trace is fully "on" when the temperature falls below the "Maintain". It is fully "off" when the RTD temperature rises above the "Maintain". (For line-sensing control this is referred to as the "Maximum" temperature.)

##### Example of "On-Off" Ambient Sensing Control:

When configured for Ambient "On-Off" Control, one or more RTD's is used to sense ambient temperature, typically in a shaded area near the control panel.

In this case, the heat trace operates at 100% power whenever the RTD temperature drops below the "Maintain" temperature. (To winterize water lines this is typically +40 to

50°F (+5 to 10°C)). when the ambient rises above this value, the heat trace will turn off.

(This is a less energy efficient approach to heat trace control, but is consistent with what is routinely provided with ambient sensing mechanical thermostats controlling a contactor between a distribution panel's main circuit breaker and the branch breaker panel board.)

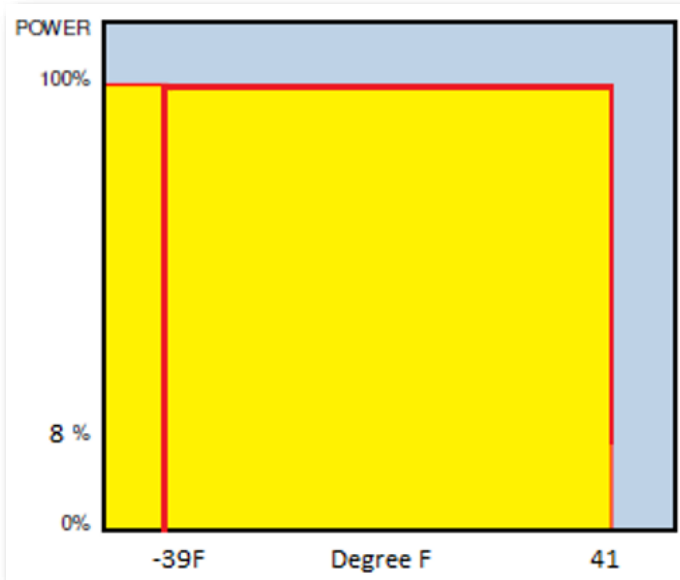

**Ambient "On-Off" Control** when ambient temperature falls below desired Maintain Temperature

#### 4.3: Control Method: On-Off with Soft Start

On-Off with soft start feature is restricted to us with Solid State Relays. It utilizes "cycle omission" techniques to ramp up to maximum allowable heater power in a span of approximately 90 seconds. This ramp-up feature is designed to specifically address a) cold start power surges associated with self-regulating and power limiting heaters, and b) potential overshoot when utilizing high wattage heaters in low heat loss applications.

This control method is only used with the zero crossing solid state current switching relay configurations as these control modes pulse power very rapidly during start-up, power clamping, and/or when employing a full proportional control algorithm.

If "on/off with soft start" is selected with any Power Clamp percentage other than 100% the circuit will operate as follows:

Below the Low Temperature alarm (LTA) setpoint, the heater will be "full on" 100% of the time.

When the temperature reaches/exceeds the LTA, the soft start feature will energize the heater "full on" for the Power Clamp (time) percentage selected (n% of 1 second) and over 90 seconds will ramp up to "full on" for 100% of the time.

Regardless of what Power Clamp (time) percentage is selected, it will take a maximum of 90 seconds for the heater to be "full on" for 100% of the time.

The heater will be turned off once the Maximum Temperature (Maintain Temperature plus Control Band, or MT+CB) is reached, even if that temperature is reached in less than 90 seconds.

Once the heater is at MT+CB (Maximum Temperature), it will continue to cycle based on the soft start settings. In other words, once MT+CB is reached the heater is de-energized until the temperature drops to the Maintain Temperature (MT), then the heater will be energized "full on" starting at the selected Power Clamp (time) percentage (n%) and will go through the 90 second ramp up to "full on" for 100% of the time, or until the MT+CB is again reached.

## Section 5: Genesis Testing and Start-Up

All heat trace circuits should be properly terminated and megger tested prior to energizing the TraceNet Genesis control panels. In addition, all pipes should be insulated with weather barrier to achieve the required temperatures to be maintained.

### Troubleshooting Tips

When starting up a newly installed heat trace and control system, it is common to encounter numerous circuit alarms and possibly circuit "trip" events. Data entry errors, unanticipated temperature conditions and/or control band settings that are too narrow, and other possible installation errors can be expected.

A table of Troubleshooting Tips is provided in Appendix C to assist during start-up.

## Section 6: Operation and Maintenance of the Genesis Control and Monitoring System

### 6.1: Maintenance

Preventive maintenance consists of inspection, testing, checking connections, and general cleaning of equipment at scheduled intervals. The maintenance recommendations that follow are intended to support and in some cases "add to" those procedures detailed in the facility's Planned Maintenance System (PMS). In case of conflicts, contact the project engineer for resolution. When carrying out the scheduled maintenance program, the following safety precautions should be observed. Safety Precautions the heat tracing can be powered by the project specified nominal voltages ranging from 100 to 600 Vac. It is important that only authorized trained personnel conduct these maintenance and service activities. Before conducting any maintenance or service procedure, exercise required lockout and tag out procedures at the appropriate circuit breakers. Additionally, do additional testing within the control panel to ensure that the specific heat tracing and control circuit of interest is fully de-energized and the equipment is grounded. If it becomes necessary to service

or test live equipment, the following instructions must be followed:

- Use one hand when servicing the equipment. Accidental death or severe injury may occur especially if a current path is created through the body from one hand to the other.
- First, de-energize the equipment. To de-energize any capacitors connected into the circuits, temporarily ground the terminals where work is to be done.
- Connect the multi-meter/instrument to the terminals of interest using a range higher than the expected. Make sure that you are not grounded whenever a need arises to adjust equipment or test circuit operation. Verify that all test equipment used is properly maintained and safe for the intended use.
- Without touching the multi-meter/instrument energize the equipment and read the values indicated on the multi-meter/instrument.
- Remove the test leads after de-energizing the circuit of interest.

## **6.2: Maintenance Schedule Recommendation**

The service schedule is somewhat dependent on the “in service” hours. As a general rule, however, it is recommended that the heat tracing control and monitoring panel be serviced on a twelve month basis to start. The schedule may be adjusted depending on the operating history of the panel and as the historical maintenance records dictate.



# TraceNet™ Genesis

CONTROL AND MONITORING SYSTEM

# QUICK START GUIDE

The TraceNet Genesis HMI serves as the central user interface.

- View Status For 72 Circuits On Dashboard
- Allows Up To 20 RTD's Per Circuit
- Communications to Host Computer via Ethernet Communications
- Reduced Wiring And Connections
- Each RTD is Addressable
- Control Panel- IP66 IP Rating

The TraceNet Genesis has a simple "glove touch" interface that allows the operator to adjust and monitor heat tracing circuits. The following steps show navigation of the controller's basic functions.

OVERVIEW

The Overview screen displays information on any circuit.

"HAMBURGER" MENU

To edit circuit values, log in by touching the "Hamburger" menu.  
Select **Admin Login**.

OVERVIEW

Rotate the teardrop cursor or use the arrows to select a circuit.  
Touch inside the circuit dial to show the Circuit Dashboard.

CIRCUIT DASHBOARD

Touch any value on circuit details to edit a setpoint.

NUMBER PAD

Edit Maintain Temp, Alarms, and Control Band using the number pad.  
Select check to accept new setpoint.

Select an icon at the bottom of any Circuit Screen::



Select **Settings** to adjust variables specific to a circuit.

Select **History** to view up to 6 months of data for the circuit.

Select **ISO** to view the isometric drawing for the circuit.

Select **Notes** to add comments to a circuit.



SETTINGS



HISTORY

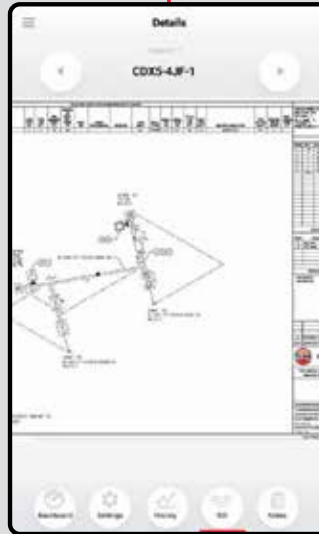

CIRCUIT ISO



NOTES

"HAMBURGER" MENU



Select the "Hamburger" menu to make global adjustments.

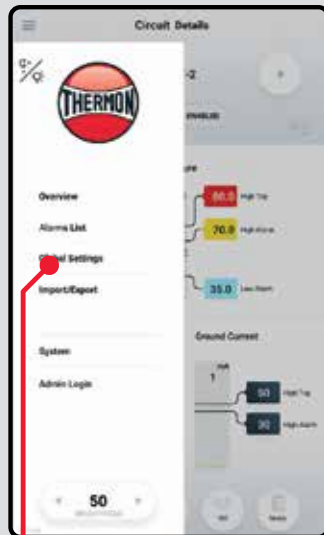

Select **Global Settings** to adjust how the Genesis displays system-wide variables such as language, temperature, system time.

GLOBAL SETTINGS



Select any value on global settings to make adjustments to circuit level or updates to global settings.

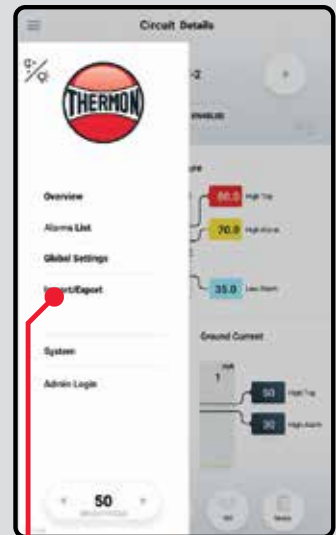

Select **Import/Export** to import or export ISO drawings and circuit-level details.



Corporate Headquarters: 7171 Southwest Parkway • Building 300, Suite 200 • Austin, TX 78735 • Phone: 512-690-0600  
For the Therman office nearest you visit us at . . . [www.thermon.com](http://www.thermon.com)

Form TEPO217-0120 © Therman, Inc. • Printed in U.S.A. • Information subject to change.

# TRACENET™ GENESIS

## CONTROL AND MONITORING SYSTEM

### SPECIFICATION GUIDE



# TRACENET™ GENESIS

## APPLICATION OVERVIEW

Control and monitoring systems can play an essential role in heat tracing applications which range from freeze protecting water lines to maintaining elevated process temperatures. While mechanical thermostats have been used successfully for many heat tracing applications, a more complete control and monitoring solution can be necessary for critical heat tracing applications. Advancements in technology have made electronic control and monitoring units both cost effective and more reliable. These systems conserve energy, extend system life, and ensure accurate temperatures are maintained, for reduced operating cost and increased plant reliability.

TraceNet Genesis' key features include:

- Monitor electric heat trace circuit load currents
- Selectable control methods (On/Off, On/Off with Soft Start, Proportional, Ambient Proportional) for each individual circuit
- Programmable alarm set points, with time delay and remote alarm acknowledgment and reset capabilities
- Programmable "trip" set-points for each circuit
- Temperature sensor status indication
- Unique circuit identifier (48 characters maximum)
- Communication to host computer via Ethernet communications
- Adjustable ground/earth leakage "trip" and/or alarm capabilities
- Addressable RTD Temperature Sensors- up to twenty (20) per circuit
- Up to 6 months history to aid in troubleshooting
- ISO drawing in png format for viewing on Genesis HMI

## GENESIS SYSTEM APPROVALS



Nonhazardous Locations  
ETL Listed Conforms to: UL STD. 508A  
Certified to: CSA STD. C22.2 NO. 14



Hazardous Locations (Purge)  
ETL Listed Conforms to: UL STD. 508A. NFPA STD. 496  
Certified to: CSA STD. C22.2 NO. 14



Hazardous Locations  
ETL Listed Conforms to: UL STD. 508A. UL STD. 12.12.01  
Certified to: CSA STD. C22.2 NO. 14. CSA STD. C22.2 NO. 213

## GENESIS COMPONENT APPROVALS

TraceNet systems are certified for nonhazardous locations, hazardous locations, and Purge for hazardous locations

IEC/EN/UL/CSA 61010-1

Ex ec IIC T4 Gc; II 3 Ex ec IIC T4 Gc

Class I, Division 2, Groups ABCD T4; Class I, Zone 2 Group IIC T4



# CONTROL AND MONITORING SYSTEM

## TRACENET GENESIS PANEL

**SYSTEM SPECIFICATIONS** (Based on lowest rating of all components)

### Environmental:

Hazardous and Ordinary Locations

- Indoor and Outdoor-Solid State Relays

Ordinary Locations

- Indoor and Outdoor- Power Distribution and Mechanical Relays

**Operating Ambient Range:** -40°C (-40°F) to 60°C (140°F)

**Enclosures:** Type 4X, IP 66 \*

**TraceNet Supply Voltage:** 100-240 Vac, 50/60 Hz

**Heat Tracing Voltages:** 100-600 Vac

**User Interface:** 231 mm x 139 mm (10.6" x 5.5") LVDS TFT LCD glove touch panel

**Maximum Number of Circuits:** Seventy-two (72)

**Temperature Sensors per Circuit:** Up to twenty (20) 100 Ω Platinum, 3 wire RTD's

### Current Switching Device Options:

Solid State Relay \*\*

1-pole

2-pole

Mechanical Relay:

Per design requirements

### Control Methods:

Process Sensing:

On/Off, On/Off Soft Start, Proportional

Ambient Sensing:

Proportional, Ambient Proportional-Mechanical (APCM), APC

Control Temperature Range: -129°C (-200°F) to 600°C (1112°F)

### Alarm Settings:

Low, High Temperature, and High Temperature Trip

Low, High Current, and High Current Trip

High Ground/Earth Leakage Current

RTD and Relay Faults

Loss of Communication

Programming Error

### Trip Settings:

High Temperature, Heater Current, Ground or Earth Leakage Current

### Networking Communications:

External: Ethernet

### External Alarm Relays:

Up to seven mechanical, 6 A @ 250 Vac or Vdc

\* Additional cabinet types are available. Contact Thermon for details.

\*\* Rating based on extended heat sinks. Multiple single pole relays may be used for two and three phase circuits. Higher voltage rated relays are also available as an option.



**HMI (HUMAN MACHINE INTERFACE)**

The HMI serves as the central monitoring and interrogation point for a TraceNet™ Genesis system, including its heat tracing control modules. Through its touch screen monitor, the HMI allows the operator to access operating control parameters and operating conditions throughout the heat tracing system network.

The HMI communicates directly with TraceNet Command and DCS systems through its Ethernet port.

**HMI SPECIFICATIONS**

Operating supply voltage .....	24 Vdc
Max Power consumption .....	30 Watts
Clock speed .....	1.5 GHZ
Processor .....	32 Bit Arm Cortex A15
IP Rating .....	Type 4X, IP66
Brightness .....	1000 cd/m <sup>2</sup>
Input/Output ports .....	Ethernet/USB
Maximum storage temperature .....	85°C (185°F)
Minimum storage temperature .....	-40°C (-40°F)
Operating ambient temperature range .....	-40°C (-40°F) to 70°C (158°F)
Weight .....	2.72 kg (6 lbs.)

**HMI DIMENSIONAL DATA**



Circuit History For Trending



Circuit Dashboard



Circuit Isometric Drawing



"Glove Touch" User Interface

**HMI PRODUCT FEATURES**

- TraceNet Genesis HMI Is IP66
- Module operates in a wide range of ambient conditions
- Multi-language capability
- Color display utilizes LED backlighting to maximize service life and is additionally programmable for "sleep mode" operation
- Utilizes projected capacitive touch screen for user input functions
- Intuitive user friendly graphical interface
- Type 4X, IP66 panel mount enclosure which may be installed on panel with access door or inside on panel swingout
- Optically bonded display for bright sunlight visibility

# TRACENET™ GENESIS

## CONTROL AND MONITORING SYSTEM

### DCM (DISTRIBUTED CONTROL MODULE)

The DCM serves as the power switching module, using solid state relays for a TraceNet™ network of heat tracing control modules.

### DCM FEATURES

- Operates in a wide range of ambient conditions
- Single or dual pole solid state switching
- Nickel plated terminal construction
- Black anodized aluminum heat sink capable of dissipating the heat generated for up to a total of 180 Amps continuous
- Includes a ground/earth leakage circuit test loop which allows the operator to conduct a functionality test on each circuit
- The DCM module has the following control modes:
  1. On-Off
  2. On-Off with Soft-Start (solid state relays only)
  3. Proportional (solid state relays only)
  4. Ambient Proportional (solid state relays only)
  5. Ambient Proportional- Mechanical
- Activates test functions including:
  1. Ground/Earth Leakage Fault Circuit Test
  2. Loss of Heater Current Test
- Activates programmed control function based on the temperature values provided by up to 20 RTD's per circuit
- Monitors ground/earth leakage and heater operating current in heat tracing circuits

### DCM CONNECTION DIAGRAM

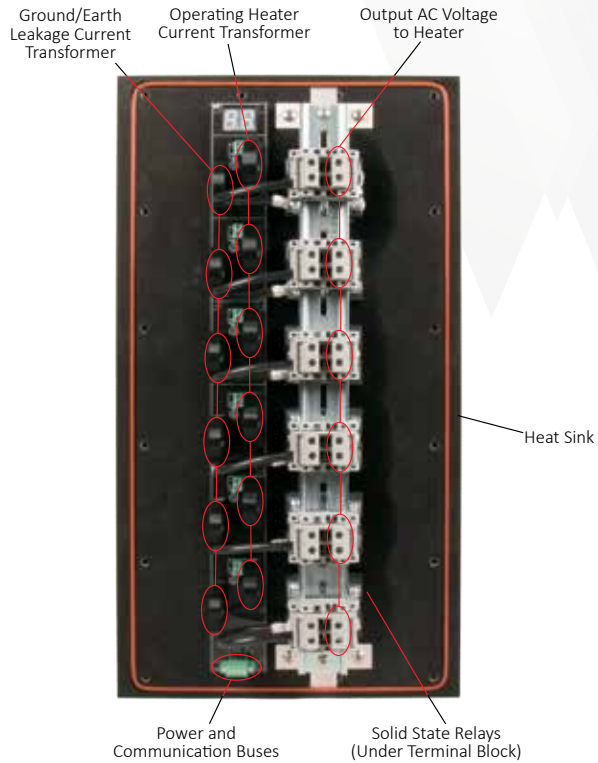

### DCM COMPONENT SPECIFICATIONS

Circuit control capacity ..... up to six heat trace circuits  
 Storage ambient temp. range..... -40°C (-40°F) to 105°C (221°F)  
 Operating ambient temp. range... -40°C (-40°F) to 100°C (212°F)  
 Power terminal connections<sup>1</sup>  
 0.5 to 10 mm<sup>2</sup> (20 to 6 AWG), 630 Vac  
 Printed circuit board ..... conformal coated  
 Heat sink ..... Type 4X, IP66  
 Weight..... 8 kg (17.63 lbs.)

1. DIN-rail mounted terminal blocks for line voltage to be off PC board.

### DCM DIMENSIONAL DATA

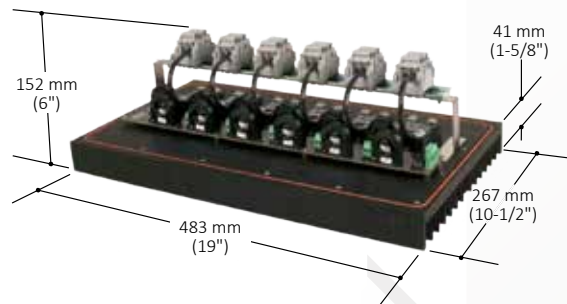

**DTM (DISTRIBUTED TEMPERATURE MODULE)**

The DTM is a DIN rail mountable six RTD sensor input module which links the field RTD wiring to the DCM module via CANBus. Any RTD sensor may be mapped to any heater circuit on the CANBus network.

**DTM DIMENSIONAL DATA**

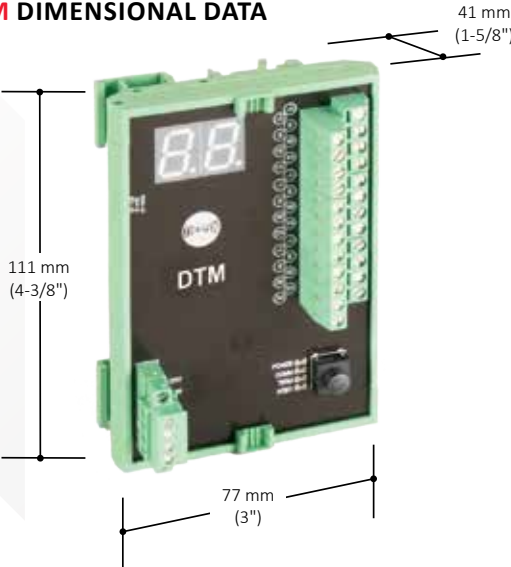

**DTM PRODUCT FEATURES**

- Up to six RTD sensors that can be independently addressed to one or more heat trace circuits
- DIN rail mountable
- Conformal coated printed circuit board for use in panels located in indoor and outdoor environments

**DTM COMPONENT SPECIFICATIONS**

Storage ambient temp. range..... -40°C (-40°F) to 105°C (221°F)  
 Operating ambient temp. range. -40°C (-40°F) to 100°C (212°F)<sup>1</sup>  
 Terminal connections..... up to 2.5 mm<sup>2</sup> (28-12 Awg)  
 Maximum RTD capacity ..... 6  
 Weight..... 123.32 g (4.35 oz.)

1. For designs that allow operation in ambient conditions below -40°F (-40°C) contact Thermon..

**DTM CONNECTION DIAGRAM**



**IOM (INPUT OUTPUT MODULE)**

The IOM is a DIN rail mountable input/output module with 6 individually configurable input/output channels and one dedicated system fault alarm output. Outputs may be configured to signal a variety of conditions such as trips, low temperature alarms, ground/earth leakage alarms, etc. Inputs may be used to trigger a variety of events such as load shed or forcing on circuits.

**IOM DIMENSIONAL DATA**

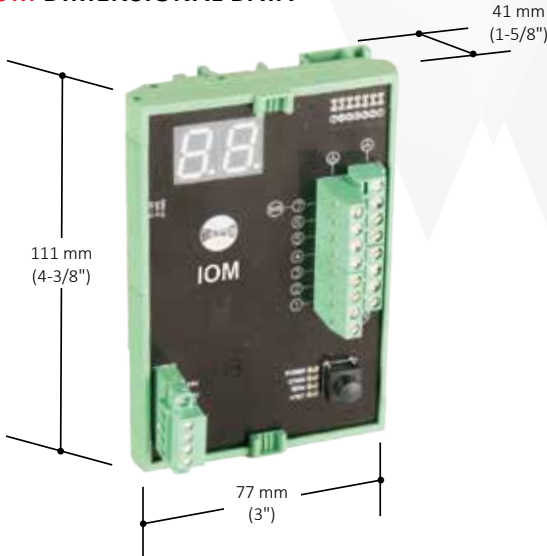

**IOM PRODUCT FEATURES**

- Operates in a wide range of ambient conditions
- DIN rail mountable
- Conformal coated printed circuit board for use in panels located in indoor and outdoor environments

**IOM COMPONENT SPECIFICATIONS**

Storage ambient temp. range..... -40°C (-40°F) to 105°C (221°F)  
 Operating ambient temp. range. -40°C (-40°F) to 100°C (212°F)<sup>1</sup>  
 Terminal connections..... up to 2.5 mm<sup>2</sup> (28-12 Awg)  
 Weight..... 116.52 g (4.11 oz.)

**IOM CONNECTION DIAGRAM**

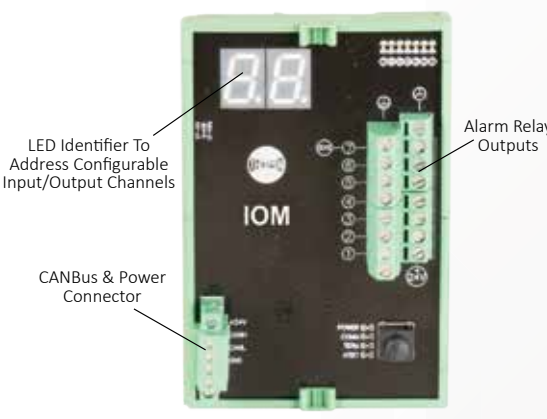

# TRACENET™ GENESIS

# CONTROL AND MONITORING SYSTEM

## TRACENET COMMAND

Genesis Systems communicate via Ethernet to the Thermon TraceNet Command electric tracing circuit monitoring software. TraceNet Command provides centralized electric tracing information for all panels in a facility, such as:

- Heat tracing circuit status
- Temperatures, heater operating and earth/ground current alarm/trip events
- Event history
- Data trending
- Maintenance and troubleshooting guidance

TraceNet Command also gives the operator the ability on all panels from a single location to:

- Change set points as well as alarm and trip values
- Reconfigure system control parameters
- Provide heat tracing management reports
- Load shed circuits on a priority level basis



## DCS (DISTRIBUTED CONTROL SYSTEMS) COMMUNICATIONS

Genesis Systems communicate via Ethernet to the plant DCS. The same operating data and control capabilities that are available through TraceNet Command are also accessible in the plant control room at the DCS.

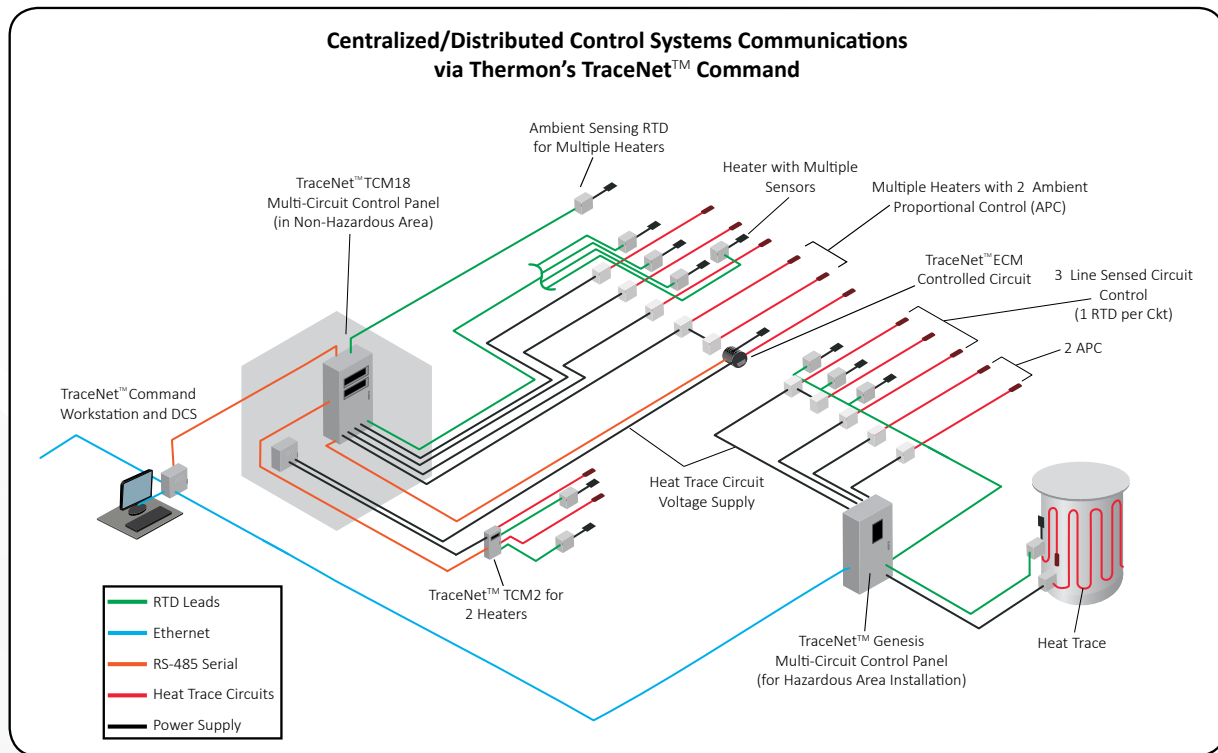

# PRODUCT REFERENCE LEGEND

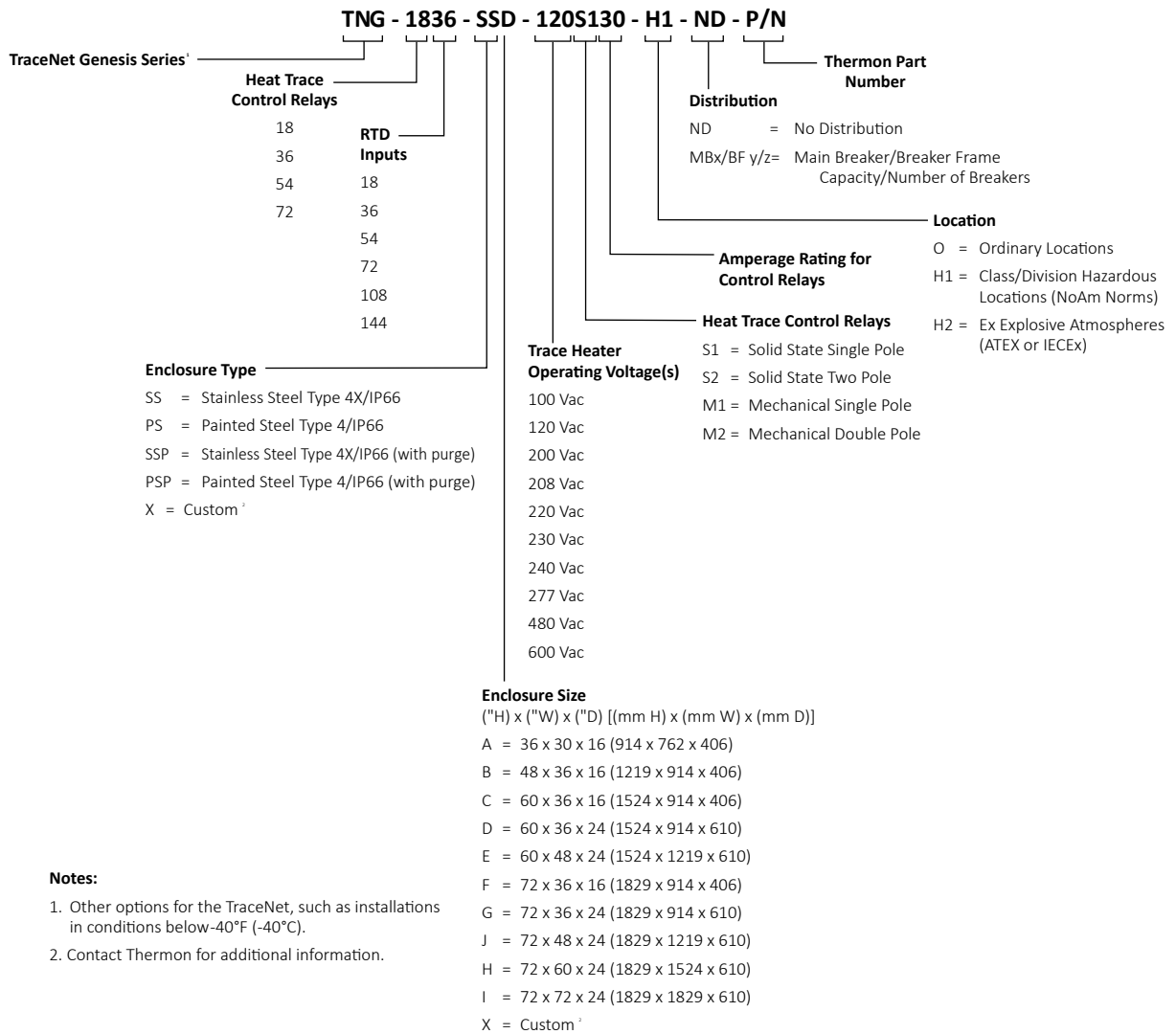



Corporate Headquarters: 100 Thermon Dr • PO Box 609 San Marcos, TX 78667-0609 • Phone: 512-396-5801 • 1-800-820-4328  
For the Thermon office nearest you visit us at . . . [www.thermon.com](http://www.thermon.com)  
Form TEP0212-0419 © Thermon, Inc. • Printed in U.S.A. • Information subject to change.

## Appendix C: Troubleshooting Tips For Reliable Electrical Heat Trace Performance

### Troubleshooting Tips

Troubleshooting tips are provided here as a beginning point in correcting start-up issues and clearing out alarm and trip events.

### High Temperature Reading/Alarm

The following summarizes some of the possible causes and solutions for heat tracing high temperature alarms.

Possible Cause	Recommended Solutions
Temperature of product in process line is above alarm set point or the expected reading due to events other than heat tracing—high processing temperatures, steam-outs, etc.	Let process return to normal condition or adjust alarm set point (if approved by project engineer) to allow for this processing condition.
High alarm setting programmed or expected reading did not consider natural temperature overshoot associated with the control scheme.	Move control set point down to allow for overshoot or raise the high temperature alarm set point (if approved by project engineer). It may also be possible to decrease the control band on the control circuit or adjust the type of control from on-off to proportional.
Improperly located RTD sensor.	Is the RTD sensor installed next to a heated tank or a steam jacketed pump that might cause a higher than expected reading? Is the RTD sensor on the heater itself? Move the RTD sensor to location more representative of the majority of the piping. Is the sensor location representative for properly controlling under all flow scenarios? Review location of the RTD(s) with respect to the known process flow patterns which occur and change as appropriate.
Wrong insulation size, type, or thickness on all of the line being traced.	Measure circumference of insulation, divide by $\pi$ , and compare to insulation diameter charts for proper over sizing. Check insulation type and thickness against design specification. Replace insulation or review system design for alternate operating possibilities.
Wrong insulation size, type, or thickness on part of the line being traced.	The insulation system should be as specified in the design for the entire circuit being traced. Having a lower heat loss on one part of the circuit and higher heat loss insulation on the other part of the circuit (perhaps where the RTD sensor is) will result in the better insulated line being too hot. Redo the insulation to assure uniformity and consistency.
Damaged RTD temperature sensor.	Disconnect RTD sensor and measure resistance. Compare to resistance tables for corresponding value of temperature. Compare to pipe or equipment temperature known by another probe or sensor. If different, the RTD sensor may need replacement.
Heat tracing over designed in heat output and or/ due to cable availability or natural design selections available. This can result in higher than expected temperatures due to overshoot (especially when used with on-off control mode). This can also occur in an ambient sensing control modes.	Review design as well as installation instructions. Check heat tracing for presence of proper current. Since replacing the circuit may not be a desirable option here, the first approach should be to adjust the control method which the TraceNet control system has been configured in.
Heat tracing circuits are mis-wired such that the RTD for circuit 1 is controlling circuit 2, etc.	Trace and recheck field and panel wiring. Use circuit "turn-on " and "turn-off" technique or disconnect RTD's one at a time to see if the proper RTD failure alarm occurs on the right circuit. Let process return to normal condition or adjust alarm set point (if approved by project engineer) to allow for this processing condition.

## Low Temperature Reading/Alarm

The following summarizes some of the possible causes and solutions for heat tracing low temperature readings/alarms.

Possible Cause	Recommended Solutions
Temperature of product in process line is below the alarm set point or expected reading due to events other than heat tracing—low pumping temperatures, etc.	Let process operations return to normal conditions and then recheck for alarms. Alternately adjust alarm set point (with project engineers approval) to allow for this process condition.
Low temperature alarm programmed setting or expected reading did not consider natural temperature undershoot associated with control scheme.	Move control set point up to allow for natural undershoot or lower the low temperature alarm set point (when approved by project engineer).
Damaged, open, or wet thermal insulation does not allow the heat provided to hold the desired temperature.	Repair damage to insulation.
Wrong insulation size, type, or thickness on all of circuit being traced.	Measure circumference of insulation, divide by $\pi$ , and compare to insulation diameter charts for proper over sizing. Check insulation type and thickness against design specification. Replace insulation or review system design for alternate operating possibilities which involve more heat output.
Wrong insulation size, type, or thickness on part of circuit being traced.	The insulation system should be as specified in the design for the entire circuit being traced. Having a high heat loss on one part of the circuit and a lower heat loss insulation on the other part of the circuit (perhaps where the sensor is) will result in the poorly insulated line being too cold. Redo the insulation to assure uniformity and consistency.
Improperly located RTD temperature sensor.	Is RTD sensor next to pipe support, equipment, or other heat sink? Move RTD sensor to location more representative of the majority of the piping.
Improperly installed RTD temperature sensor or RTD temperature probe.	Permanent RTD temperature sensors are most accurate when installed along the pipe or equipment with at least a foot of probe and sensor wire running along the pipe before exiting through the insulation. Permanent RTD sensors which enter the insulation at 90 degrees may be more sensitive to error associated with them, depending on insulation installation or how well the sensor is physically attached. Adjust control set point to compensate for any accuracy offset. When using a 90 degree RTD probe for diagnostics, verify this measurement technique on a known pipe in the same general temperature range and insulation configuration.
Damaged RTD sensor.	Disconnect RTD sensor and measure resistance. Compare to resistance tables for corresponding value of temperature. Compare to pipe or equipment temperature known by another probe or sensor. If different, the RTD sensor may need replacement.
Heat tracing undersized, improperly installed or damaged.	Review design/installation. Check heat tracing for presence of proper current and also meg for dielectric resistance. Repair or replace heat tracing.
Heat tracing circuits are wired such that the RTD for circuit A is controlling circuit B, etc.	Trace and recheck field and panel wiring. Use circuit “turn-on “ and “turn-off” technique or disconnect RTD’s one at a time to see if the proper RTD failure alarm occurs on the right circuit.
Heat tracing does not heat. Breaker has been switched off due to maintenance activities or has possibly malfunctioned.	As soon as maintenance activities cease and after conferring with operations manager, switch breaker back ON. Note that some period of time will elapse before the temperature alarm goes away (pipes and equipment take time to heat up).



## RTD Sensor Alarm

The following summarizes some of the possible causes and solutions for a heat tracing RTD sensor reading alarm.

Possible Cause	Recommended Solutions
RTD connections are wired improperly or have become loose.	Confirm wiring and connections are correct.
RTD has failed open or has extremely high resistance or RTD has failed shorted or has very low resistance.	Perhaps lightning has damaged the sensor? Maybe the piping has had some welding going on nearby? Maybe the RTD has gotten wet? Replace RTD.

## Communications Alarm

The following summarizes some of the possible causes and solutions for heat tracing communications alarms.

Possible Cause	Recommended Solutions
Improperly set controller address, duplicate addresses, or improper configuration of firmware/software.	Change controller address or reconfigure firmware/software.
Loose or open connection in RS485 line.	Recheck for continuity in all communication lines.
Too many modules in network.	Check network limitations versus actual configuration.
Too long of an accumulated communication distance.	Consider the addition of a repeater.
Too many reflections of signal usually caused by improper terminations in network.	Add termination resistors as appropriate.

## Circuit Fault Alarm

The following summarizes some of the possible causes and solutions for heat tracing circuit fault alarms.

Possible Cause	Recommended Solutions
Upon initial installation start-up, improper wiring of the relay or low current in heater.	Confirm correct wiring and presence of the heater. Where normal operating amperage is in range of 0 to 250 mA, disabling the Self-Test function or adding multiple loops through the current sensing toroid may be required.
During daily operations; possibly indicates relay contact failure.	If relay has failed, replace.
Breaker off.	Turn on breaker after conferring with operations manager.

## High Current Readings/Alarms

The following summarizes some of the possible causes and solutions for heat tracing high current readings or alarms.

Possible Cause	Recommended Solutions
Self regulating heater or power limiting heater current may exceed set value during normal operation or start-up operation.	Increase high current alarm set point (if approved by project engineer). For startup operation current alarm nuisances, it may also be desirable to increase the delay time (before a current reading is done after turn on) set in the controller.
Self-regulating or power limiting heater may be operating at cooler than design pipe temperatures due to processing conditions and thus heaters may be drawing higher current values.	Increase high current alarm set point (if approved by project engineer).
Self-regulating or power limiting heater may be operating in its cold start regime.	When reading current on one of these type heaters, it is necessary to read the current at steady state. One may have to wait as long as 5 minutes for heater steady state values. After five minutes the current value will continue to drop as the pipe or equipment begins to warm.
Heater circuit may be longer than anticipated in the design stage.	Verify installed length (if possible) and if different review design. If length is different but performance-wise the "as built" design is acceptable, initiate "as built" drawing change and change controller high current setting.
Wrong heater wattage or heater resistance may be installed.	Check heater set tags or markings on heater cable against installation drawings. As an additional check, disconnect heater from power and measure DC resistance.
Heat tracing may be powered on wrong voltage.	Recheck heater supply voltage.
Current sensing circuitry may have encountered a problem.	Use a different current clamp type meter which is known to be accurate and do a comparative reading. Investigate current measurement circuitry further. Note that one should only read heater currents when the heater is 100% on.
Field heater wiring is improperly labeled and/or connected such that the heater and the circuit number are not matched.	Trace out the circuit wiring from the field back into the panel and subsequently to the controller. Wherever possible, turn the circuit "off" and "on" and watch for an appropriate response. If this is the problem, redo the wiring.
Short circuit in a series resistance circuit.	Disconnect heater from power, meg between each of the conductors and ground for proper dielectric rating. If okay, measure resistance of circuit for agreement with design values.

## Low Current Readings/Alarms

The following summarizes some of the possible causes and solutions for heat tracing low current readings or alarms.

Possible Cause	Recommended Solutions
Self-regulating or power limiting heater may be operating at higher than design pipe temperatures due to processing conditions and thus heaters may be drawing lower current values.	Decrease low current alarm setpoint (if approved by project engineer).
Loss of a branch of the heat tracing circuit.	Measure total current and each branch current. Compare to design values. Check all connections.
Breaker off.	Turn breaker back on after conferring with operations manager.
Heat tracing cable may have been exposed to temperatures in excess of their maximum temperature ratings (excessive steam-out temperatures or upset process temperature events) and could have damaged the heater.	Replace heater.
Controller may be in error in reading current.	Use a different current clamp type meter which is known to be accurate and do a comparative reading. If the current measuring circuitry is in error, investigate controls further. Note that one should only read heater currents when the heater is 100% on.
Heater circuit may be shorter than anticipated in the design stage.	Verify installed length (if possible) and if different review design. If length is different but performance-wise the "as built" design is acceptable, initiate "as built" drawing change and change controller low current setting. Check heater set tags or markings on heater cable against installation drawings. As an additional check, disconnect heater from power and measure DC resistance.
Wrong heater wattage or heater resistance may be installed.	Measure pipe temperature and measure steady-state heater current, voltage, and length. Compare to manufacturer's rated power curve. Replace heat tracing cable if necessary.
Heat tracing may be powered on wrong voltage.	Recheck heater supply voltage.
Current sensing circuitry may have encountered a problem.	Use a different current clamp type meter which is known to be accurate and do a comparative reading. Investigate current measurement circuitry further. Note that one should only read heater currents when the heater is 100% on.
Field heater wiring is improperly labeled and/or connected such that the heater and the circuit number are not matched.	Trace out the circuit wiring from the field back into the panel and subsequently to the controller. Wherever possible, turn the circuit "off" and "on" and watch for an appropriate response. If this is the problem, redo the wiring.
Open circuit in a series resistance circuit.	Disconnect heater from power, meg between each of the conductors and ground for proper dielectric rating. If okay, measure resistance of circuit for agreement with design values.

## High Ground Current Alarm

The following summarizes some of the possible causes and solutions for heat tracing high ground current alarm.

Possible Cause	Recommended Solutions
Heat tracing is damaged.	Disconnect heat tracing circuit and determine if alarm clears. If so, repair heat tracing.
Wiring to heat tracing had high leakage current.	Disconnect heat tracing and sequentially disconnect power wiring until the alarm ceases. Check last section removed for damage.
Improper wiring of current sense wires through toroid.	The current sensing toroid must have the outgoing heater current lead and the return current heater lead run through the toroid for a proper ground leakage measurement. Redo wire routing if only one wire has been run through the current sensing toroid.
Heat tracing power wires in a multiple circuit system improperly paired.	If the return current wire in the toroid is from a different circuit the two heater currents will not cancel and leave only leakage to be measured. Correct wiring.
Heat tracing circuit has higher than expected leakage due to circuit length or higher voltage.	Replace the EPD breaker with a higher ground current trip device if available. Where a controller (with variable leakage trip functions) is doing the ground leakage detection function, increase ground leakage alarm set point (if approved by project engineer).

If issues remain after exercising all these possible causes and solutions for heat tracing alarms and trips, contact your nearest Thermon engineering center for assistance and/or for arranging for field service.

# Appendix D: Genesis Modbus Memory Reference

## TraceNet Genesis Panel Customer Modbus Memory Map

Circuit Settings				
FUNCTION CODE	Memory Location (CKT1)		Description	Allowed Values
	DEC	HEX		
Add CKT# x 100 to Base Memory Location to get the MODBUS Data Address CKT 1's Maintain Temp = 101 + 1*100 = 101 (0x0064) CKT 72's Maintain Temp = 101 + 72*100 = 7201(0x1C21) (Values below represent ckt 1's location)				
03/06	100	0x0064	Alarm Acknowledge	Bit Value 0x8000(bit) High Current Trip 0x4000(bit) Programing error 0x2000(bit) Current over .5A when circuit off 0x1000(bit) High Ground Trip bit 0x0800(bit) RTD Fault No Communication for all assigned RTD's 0x0400(bit) High Temperature trip 0x0200(bit) RTD Fault ( all assigned RTD's in fault) 0x0100(bit) Not Used 0x0080(bit) High Current 0x0040(bit) Low Current 0x0020(bit) Circuit Fault 0x0010(bit) High ground current 0x0008(bit) RTD Fault No Communication 0x0004(bit) High temperature Alarm 0x0002(bit) RTD Fault (one or more assigned RTD's in fault) 0x0001(bit) Low temperature Alarm
03/06	101	0x0065	Maintain temp	10x True Value
03/06	102	0x0066	Control Band	10x True Value
03/06	103	0x0067	High Temperature Trip Alarm	
03/06	104	0x0068	High Temp Alarm	
03/06	105	0x0069	Low Temp Alarm	10x True Value
03/06	106	0x006A	High Ground Fault Trip Alarm	Value in (ma)
03/06	107	0x006B	High Ground Fault Alarm	Value in (ma)
03/06	108	0x006C	High Current Alarm Trip	10x True Value (A)
03/06	109	0x006D	High Current Alarm	10x True Value (A)
03/06	110	0x006E	Low Current Alarm	10x True Value (A)
03/06	111	0x006F	Circuit Enable/ Status	Bit definitions 0x0008(bit) Heater Forced Off = 1 normal = 0 0x0004(bit) Heater Forced On = 1 normal = 0 0x0002(bit) Heater Tripped = 1 normal = 0 0x0001(bit) Heater Enabled = 1 , Disabled = 0
03/06	112	0x0070	Control Type	0 = On/Off 1 = On/Off with a Soft Start 2 = Proportional 3 = Ambient Proportional Mechanical 4 = PID
03/06	113	0x0071	Number of RTDs per Circuit	1 to 20
03/06	114	0x0072	RTD Fault power	Range = 0 to 100%
03/06	115	0x0073	Power Clamp	Range = 0 to 100%

Circuit Readings			
Function Code	Base Memory Location (CKT1)	Description	Notes

	Dec	Hex		
Add CKT# x 100 to Base Memory Location to get the MODBUS Data Address (Values offset from the CANBus memory map by -80 eg alarms in CANBus is memory location 185, in Modbus is 185)				
4	100	0x064	Control Temperature for the DCM RTD Reading for the DTM	Value x10  This location on the DCM is the temperature that it has decide to control off.  This location on the DTM is an RTD reading.
4	101	0x065	Which DTM and RTD that the circuit is controlling from	low Byte = DTM address 1-199 High Byte = RTD from DTM 1-6
4	102	0x066	Heater Current	Value x 10 (A)
4	103	0x067	Ground Current	Value in (ma)
4	104	0x068	Heater Percent On	Range = 0-100%
4	105	0x069	Alarms	Bit definitions 0x8000(bit) High Current Trip 0x4000(bit) Programing error 0x2000(bit) Current over .5A when circuit off 0x1000(bit) High Ground Trip bit 0x0800(bit) RTD Fault No Communication for all assigned RTD's 0x0400(bit) High Temperature trip 0x0200(bit) RTD Fault ( all assigned RTD's in fault) 0x0100(bit) Not Used 0x0080(bit) High Current 0x0040(bit) Low Current 0x0020(bit) Circuit Fault 0x0010(bit) High ground current 0x0008(bit) RTD Fault No Communication 0x0004(bit) High temperature Alarm 0x0002(bit) RTD Fault (one or more assigned RTD's in fault) 0x0001(bit) Low temperature Alarm
4	109	0x06D	RTD 1 Temperature Reading	Value x10
4	113	0x071	RTD 2 Temperature Reading	Value x10
4	117	0x075	RTD 3 Temperature Reading	Value x10
	...			
4	185	0x0B9	RTD 20 Temperature Reading	Value x10

## Appendix E: Recommended Wiring For RS 485 Communications

Cable Type	Recommended
120 ohm, -20°C to +60°C (-4°F to +140°F) 22AWG FHDPE insulation PVC outer jacket	Belden 3107A or equal
120 ohm, -30°C to +80°C (+22°F to +176°F) 24AWG PE insulation PVC outer jacket	Belden 9842 or equal
120 ohm, +70°C to +200°C (+94°F to +392°F) 24AWG Teflon FEP insulation, Teflon FEP outer jacket	Belden 89842 or equal





Corporate Headquarters: 7171 Southwest Parkway • Building 300, Suite 200 • Austin, TX 78735 • Phone: 512-690-0600  
For the Thermon office nearest you visit us at . . . [www.thermon.com](http://www.thermon.com)

PN50881-0120 © Thermon, Inc. • Printed in U.S.A. • Information subject to change.