

# Terminator DS/DE FAK-1

For Bulkhead Entry of  
Electrically Heated  
TubeTrace® Bundles

## INSTALLATION PROCEDURES



# Terminator DS/DE FAK-1

## Receiving, Storing and Handling

1. Inspect materials for damage incurred during shipping.
2. Report damages to the carrier for settlement.
3. Identify parts against the packing list to ensure the proper type and quantity has been received.
4. Store in a dry location.

## Terminator DS/DE FAK-1 Kit Contents



Item	Quantity	Description
1	1	Expediter Assembly: Flat Mount Base, Grommet, Grommet Compressor.
2	1	Splice Cap
3	1	FAK-1 Top
4	1	FAK-1 Base
5	1	Heat Reflective Tape, 1.75" Wide
6	1	Glass Fiber Tape
7	2	RTV Sealant Tube
8	1	Silicone Gasket
9	1	Self-Vulcanizing Tape

8 each stainless steel bolts, nuts and washers required (by others) for mounting. 8-32 size recommended.

## Installation Precautions

- To minimize the potential for arcing and ground-fault protection. The National Electrical Code (NEC) and Canadian Electrical Code (CEC) require ground-fault protection of equipment for each branch circuit supplying electric heat tracing.
- Installation must comply with Thermon requirements and be installed in accordance with the NEC, CEC, or any other applicable national and local codes.
- Component approvals and performance ratings are based on the use of Thermon specified parts only. User supplied power connection fittings must be listed or certified for intended use.
- De-energize all power sources before opening enclosure.
- Keep ends of heating cable and kit components dry before and during installation.
- Individuals installing these products are responsible for complying with all applicable safety and health guidelines. Proper personal protective equipment, or PPE, should be utilized during installation. Contact Thermon if you have any additional questions.

## Dimensions

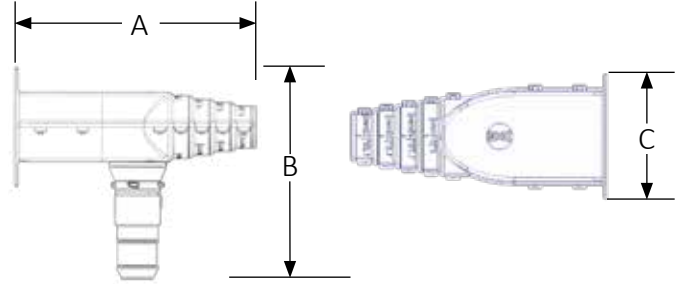

	A mm (inches)	B mm (inches)	C mm (inches)
Terminator DS/DE FAK-1	220 mm (8-5/8")	298 mm (11-3/4")	107 mm (4-1/4")

**REQUIRED:** Order separately for each heater to be fabricated.

## PETK Power and End Termination Kits (per heater)

- PETK-1D for BSX, RSX, VSX-HT  
 PETK-2D for KSX, HTSX  
 PETK-3D for FP, HPT

## Tools Required



## Terminator DS/DE Certifications/Approvals



IP66 NEMA/Type 4X -60°C ≤ Ta ≤ +55°C  
 Ordinary & Hazardous Locations  
 Class I, Division 2, Groups A, B, C, & D, Zone 2 IIC  
 Class II, Division 2, Groups F & G,  
 Class III Listed Heat Tracing System 137M

# INSTALLATION PROCEDURES

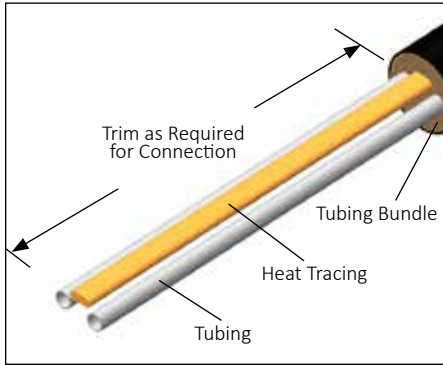

1. Remove outer jacket and insulation from tubing bundle as included from end of the tubing bundle. Ensure sufficient heat trace is available for electrical connection. See instructions included with heat trace PETK kit.

**CAUTION** Do not cut or damage the heat trace or sampling tube.  
(Found on TubeTrace SE/ME bundles)

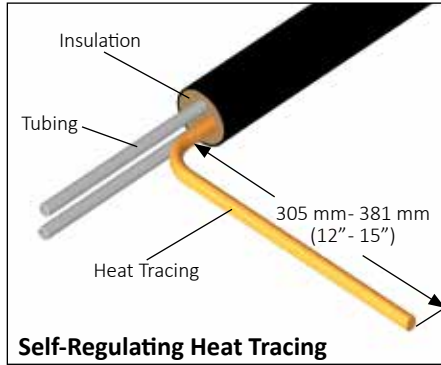

## Self-Regulating Heat Tracing

2. Trim heat tracing to within 305 mm - 381 mm (12" - 15") of the end of the insulation. If self regulating heat trace proceed to step 3. For Zone-type heat trace continue with identification of bus connection on step 2a.

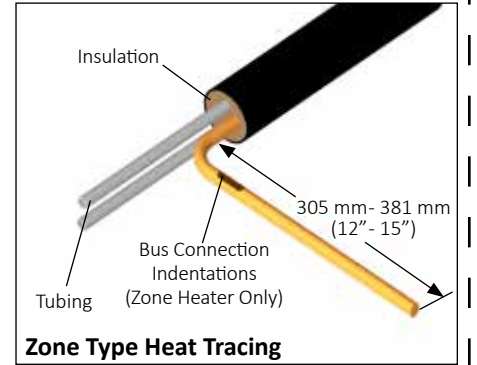

## Zone Type Heat Tracing

- 2a. Strip back bundle insulation 38 mm (1 1/2") to 76 mm (3") beyond bus connection heat tracing. If bus connection indentation is less than 305 mm (12")- 381 mm (15") from end of the heat tracing, proceed stripping the bundle insulation to the next indentation.

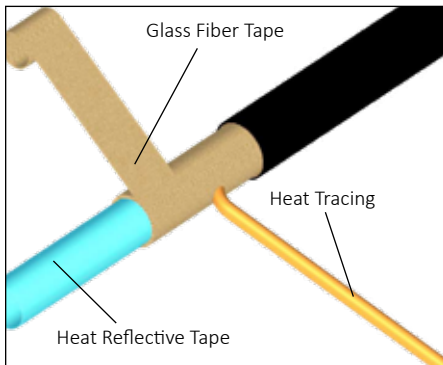

3. Wrap tubes and heat tracing with pass of heat reflective tape (25% overlap). Then wrap with 3 passes of glass fiber tape (50% overlap), or until fiber tape is equal to original bundle insulation thickness.

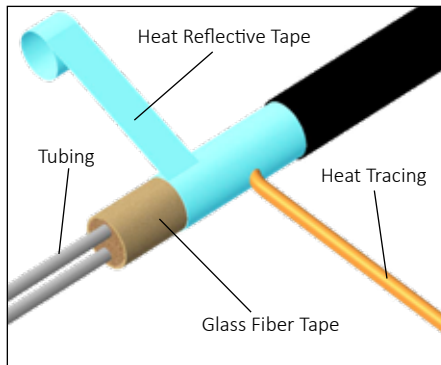

4. Complete with additional passes of heat reflective tape.

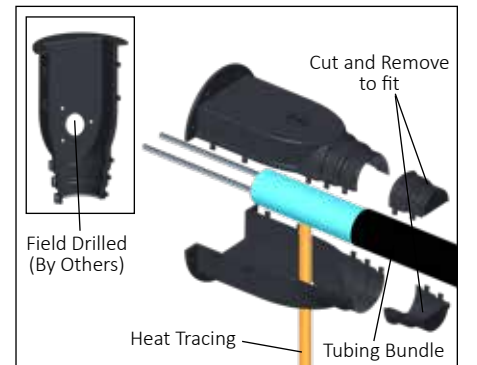

5. Cut FAK-1 top and base ends to match outside diameter of tubing bundle and remove end pieces.

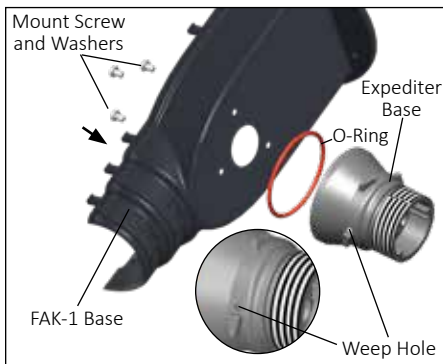

6. Mount expediter base with o-ring to FAK-1 base using (3) M5 mounting screws and lock washers. Punch out weep hole.

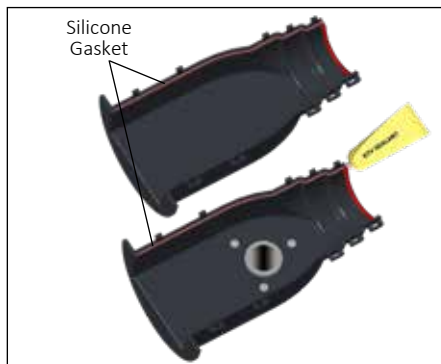

7. Install RTV silicone and gasket, cutting off excess. Apply RTV sealant to both halves.

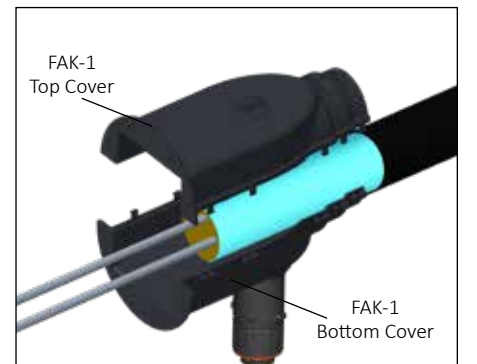

8. Assemble FAK-1 top, tubing bundle, and FAK-1 bottom together as shown. Snap together firmly. Inspect ends of tubing splice cover for snug fit. Apply additional RTV sealant where needed.

# Terminator DS/DE FAK-1



**9.** Apply self-vulcanizing tape around bundle jacket and work up over FAK ends.

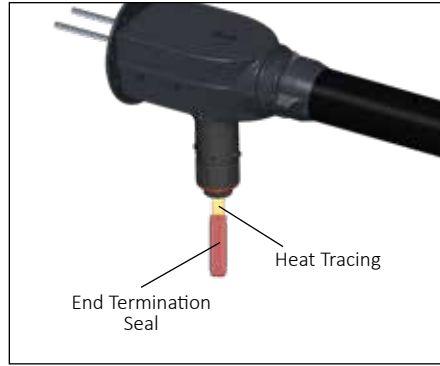

**10.** Terminate heat tracing with appropriate PETK termination kit. Refer to PETK installation instructions (purchased separately) for details not addressed here.

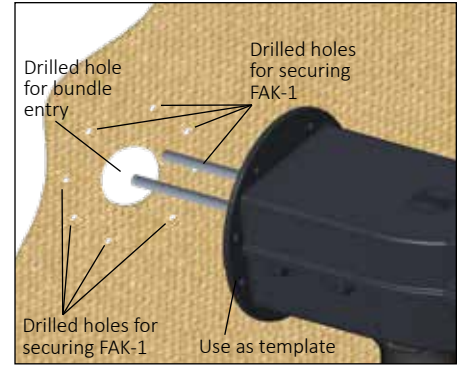

**11.** Field drill required entry hole in wall/plate. Use the FAK-1 flange as a template and mark and drill holes for bolts.

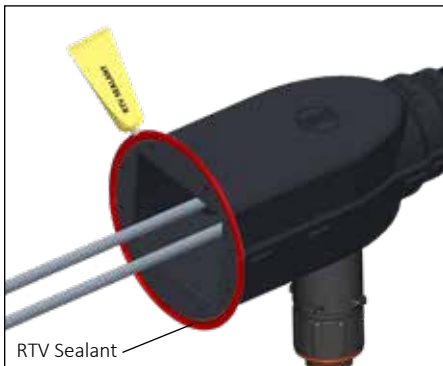

**12.** Apply RTV bead to back of FAK-1 flange prior to securing to bulkhead.

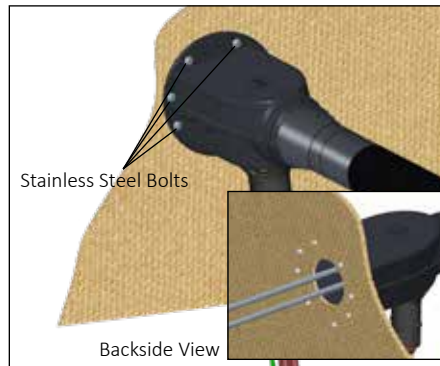

**13.** Secure FAK-1 to bulkhead/wall using (8) eight stainless steel bolts. Note: stainless steel bolts, washers, and nuts provided by others. Recommended bolt size is 8-32.



**14.** Apply RTV bead around FAK-1 flange.

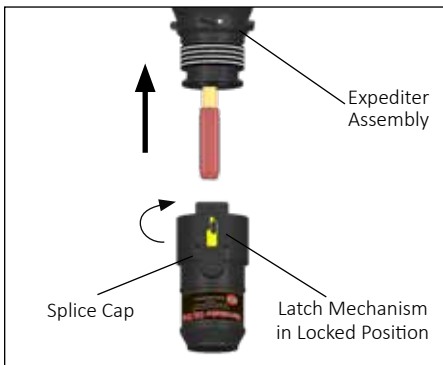

**15.** Slide the splice cap over expediter assembly and engage threads. Rotate splice cap clockwise and tighten cap securely. Make sure latch mechanism is in the locked position.



**16.** Completed Terminator DS/DE FAK-1.



**17.** To remove cap, lift latch mechanism as shown and unscrew cap counter clockwise. De-energize all power sources before opening enclosure.

