

# FAK-4LHT

In-Line Splice Kit For  
Tubing Bundles

## INSTALLATION PROCEDURES



# FAK-4LHT

The following installation procedures are suggested guidelines for the installation of the FAK-4LHT In-Line Splice Kit. They are not intended to preclude the use of other methods and good engineering or field construction practices.

## Receiving, Storing and Handling

1. Inspect materials for damage incurred during shipping.
2. Report damages to the carrier for settlement.
3. Identify parts against the packing list to ensure the proper type and quantity has been received.
4. Store in a dry location.

## FAK-4LHT: Kit Contents

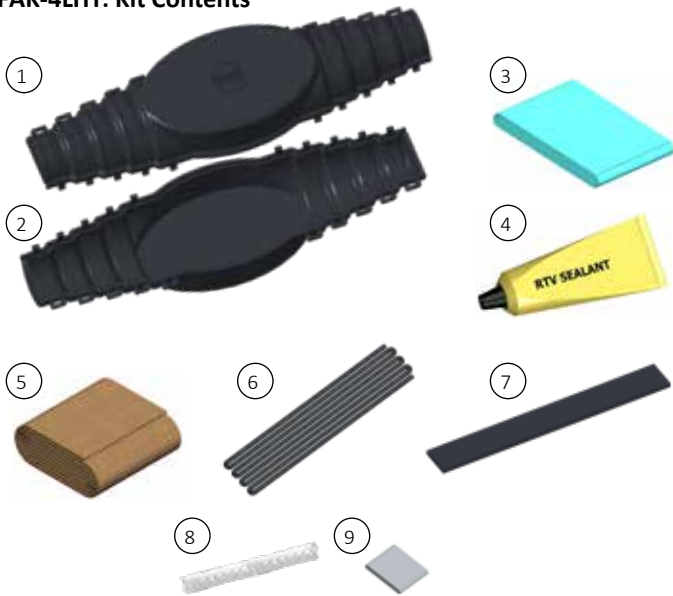

Item	Quantity	Description
1	1	In-Line Splice Cover (Top)
2	1	In-Line Splice Cover (Bottom)
3	1	Heat Reflective Tape
4	3	RTV Sealant Tube
5	1	Glass Fiber Tape
6	1	Silicone Gasket
7	1	Self-Vulcanizing Tape
8	1	Fiberglass Rope, 13 mm x 366 cm (1/2"x 12')
9	1	Heavy Foil Tape, 44.5 mm (1.75") wide

## Dimensions

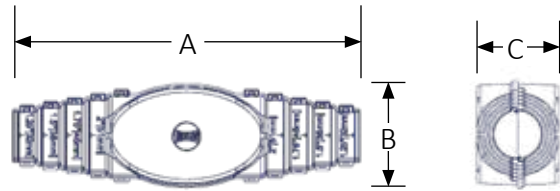

	A mm (inch)	B mm (inch)	C mm (inch)
FAK-4LHT	489 mm (19-1/4")	141 mm (5-1/2")	111 mm (4-3/8")

The FAK-4LHT In-Line Splice Kit is designed to make a waterproof seal over the end of Fluid/Steam Heated TubeTrace or ThermoTube at the splice connections. Review instructions prior to installation. Kit will make one splice connection (Tube fittings not included).

## Installation Precautions

- Installation must comply with Thermon requirements and be installed in accordance with any other applicable local codes.
- Warranty and performance ratings are based on the use of Thermon specified parts only.
- Individuals installing these products are responsible for complying with all applicable safety and health guidelines. Proper personal protective equipment, or PPE, should be utilized during installation. Contact Thermon if you have any additional questions.

## Tools Required



# INSTALLATION PROCEDURES

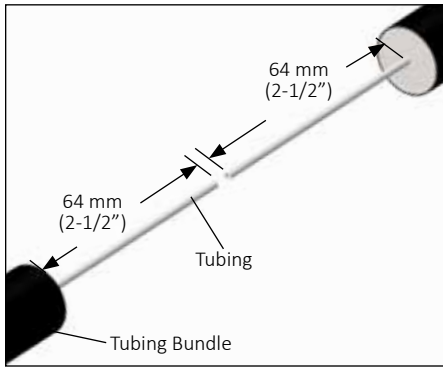

**1.** Remove outer jacket and insulation from tubing bundle approximately 64 mm (2-1/2") from each end of the tubing bundle.

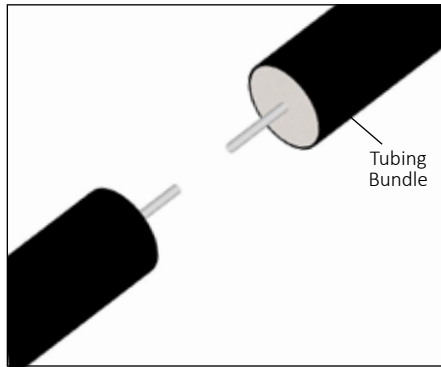

**2.** Ensure a clean, square cut. De-burr tube ends.

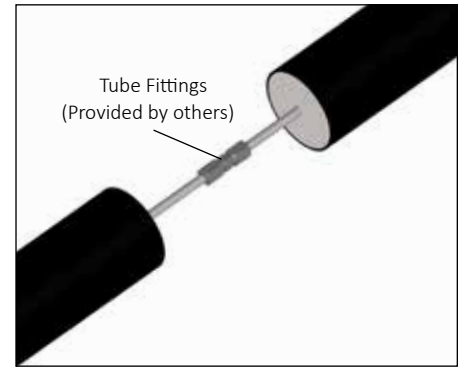

**3.** Make tube connections with appropriate fittings, provided by others. Test fittings for leaks before proceeding.

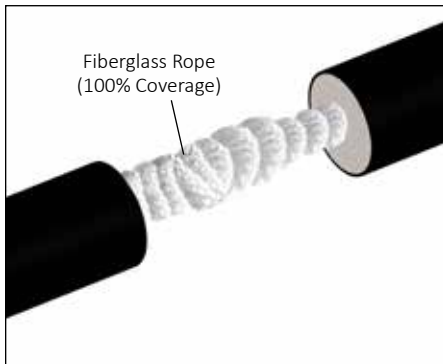

**4.** Wrap high temperature tubing with 1/2" fiberglass rope. Ensure 100% coverage.

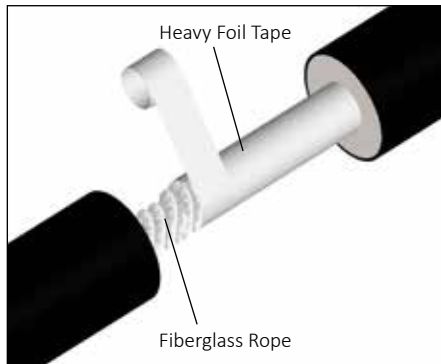

**5.** Wrap rope with one pass of heavy foil tape (25% overlap).

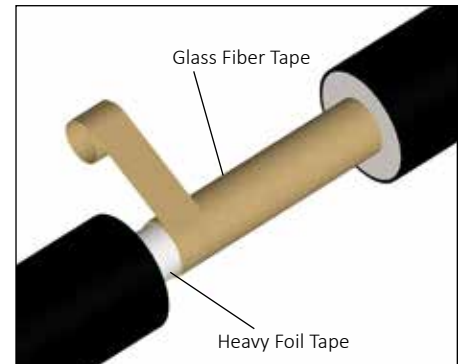

**6.** Wrap with 3 passes of glass fiber tape (50% overlap).

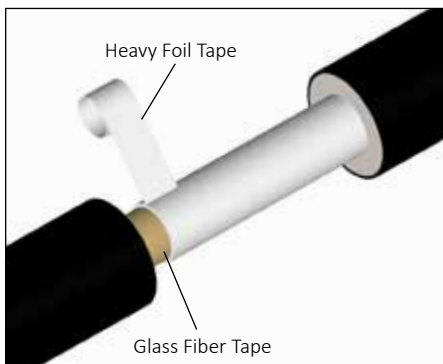

**7.** Add 1 additional pass of heavy foil tape (25% overlap).

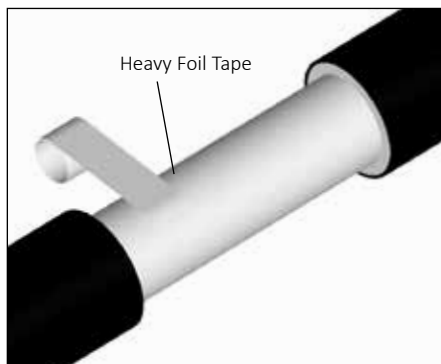

**8.** Complete with 1 additional pass of heavy foil tape (25% overlap) to cover heat trace.

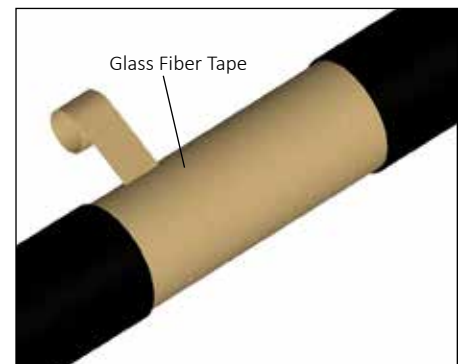

**9.** Wrap with 4 passes of glass fiber tape (50% overlap), or until fiber tape is equal to original bundle insulation thickness.

# FAK-4LHT

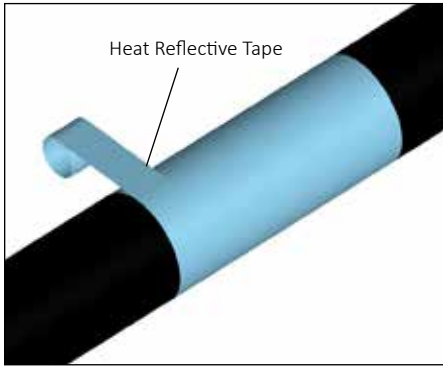

**10.** Wrap with 1 additional pass of heat reflective tape (50% overlap).

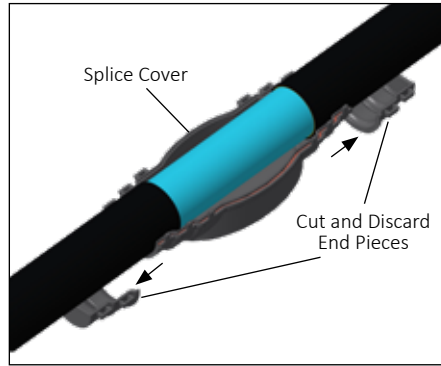

**11.** Cut top and bottom splice cover ends to match outside diameter of tubing bundle.

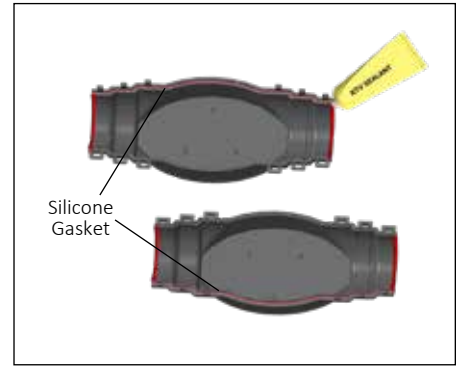

**12.** Install silicone gasket, cutting off excess. Apply RTV sealant to both halves.

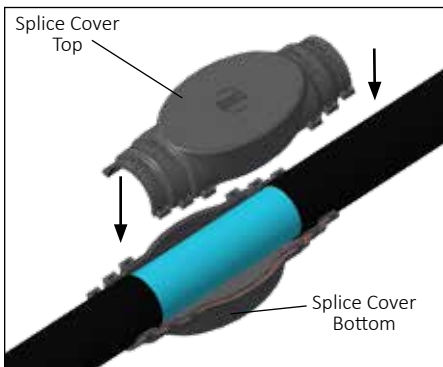

**13.** Fit tubing bundle to bottom half of cover and install top half. Snap together firmly. Inspect ends of tubing splice cover for snug fit. Apply additional RTV sealant where needed.



**14.** Apply self-vulcanizing tape around bundle jacket and work up over FAK ends.



**15.** Completed FAK-4LHT Kit.

