

PCA-COM-D

Power Connection
and End Termination Kit

INSTALLATION PROCEDURES

Power Connection, In-Line Splice Connection, T-Splice
Connection, or End Termination Applications with
DLX and DSX Heat Tracing

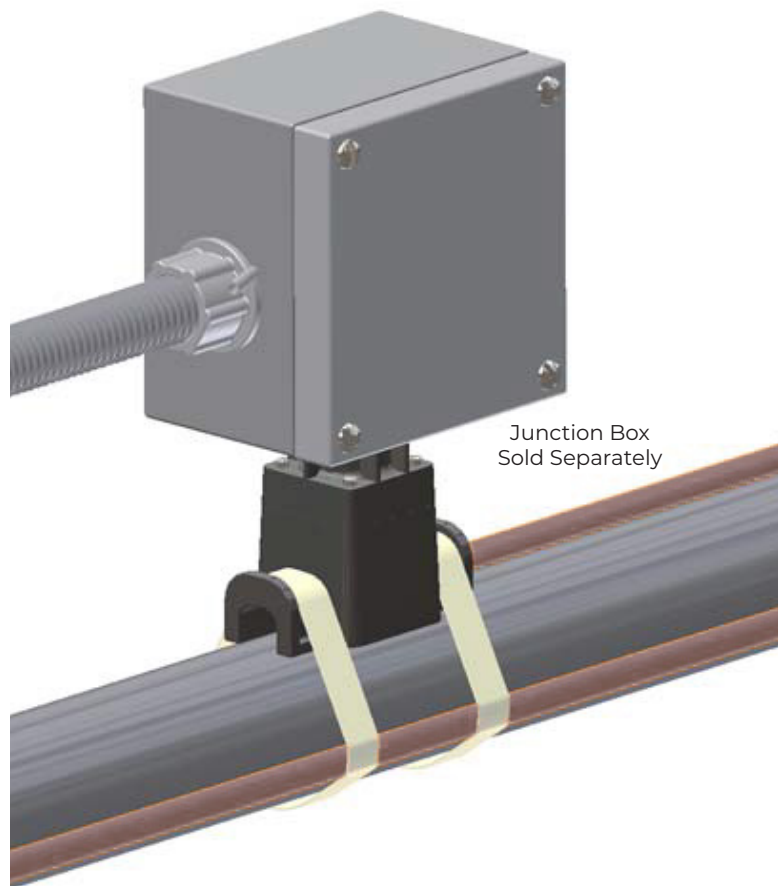

PCA-COM-D

The following installation procedures are suggested guidelines for the installation of Thermon's PCA-COM-D connection systems. They are not intended to preclude the use of other methods and good engineering or field construction practices.

Receiving, Storing and Handling

1. Inspect materials for damage incurred during shipping.
2. Report damages to the carrier for settlement.
3. Identify parts against the packing list to ensure the proper type and quantity have been received.
4. Store in a dry location.

Kit Contents

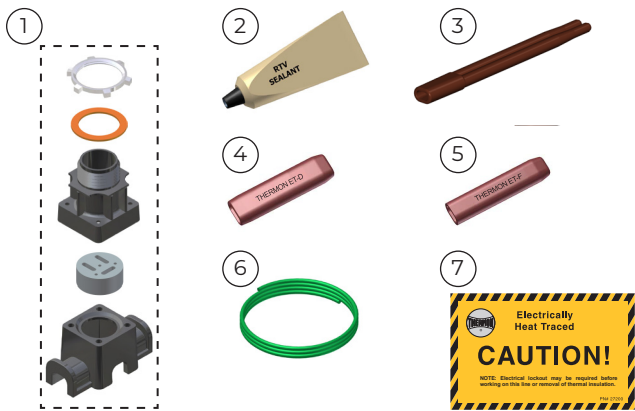

Item	Quantity	Description
1	1	Expediter Assembly Locknut Gasket 1" NPT Threaded Cap Grommet Expediter Base
2	1	RTV Tube
3	1	TBX-DL Power Connection Boot
4	1	End Cap ET-D
5	1	End Cap ET-F
6	1	12 AWG Green Ground Lead
7	1	End Termination Caution Label

Installation Precautions

- To minimize the potential for arcing and fire caused by product damage or improper installation use ground-fault protection. The National Electrical Code (NEC) and Canadian Electrical Code (CEC) require ground-fault protection of equipment for each branch circuit supplying electric heat tracing.
- Installation must comply with Thermon requirements and be installed in accordance with the NEC, CEC, or any other applicable national and local codes.
- De-energize all power sources before opening enclosure.
- Keep ends of trace heater and kit components dry before and during installation.
- Component approvals and performance ratings are based on the use of Thermon specified parts only. User supplied power connection fittings must be listed or certified for intended use.
- The kit instructions should be used in conjunction with the installation instructions for the trace heater and other accessory items.

Certifications/Approvals



Note: When used with DLX cable, the PCA-COM-D is for use in Ordinary areas only

Tools Required

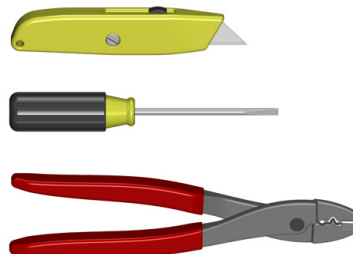

INSTALLATION PROCEDURES

Power Connection for DLX and DSX



1. For one, two or three trace heaters. Insert trace heater into expediter, grommet, and NPT threaded cap.



2. Two trace heaters.

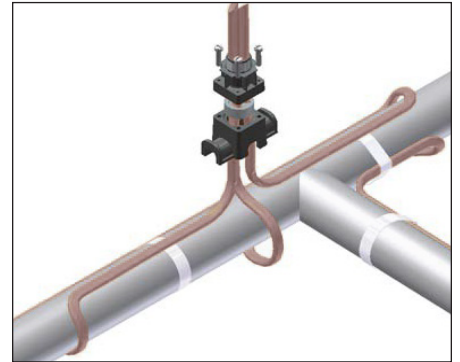

3. Three trace heaters.

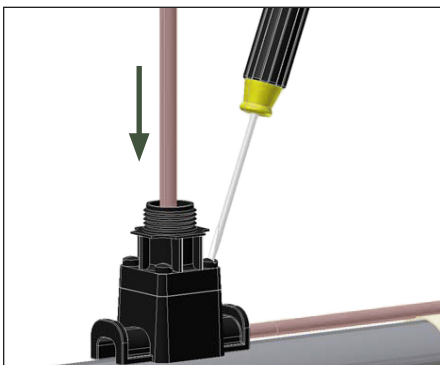

4. Slide expediter toward pipe and secure cap to base with the captive screws.

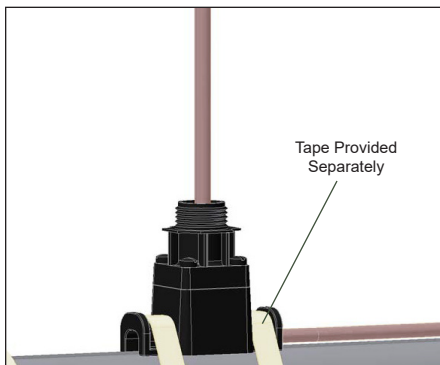

5. Mount expediter to pipe using two (2) circumferential bands of 19 mm (3/4") wide tape.

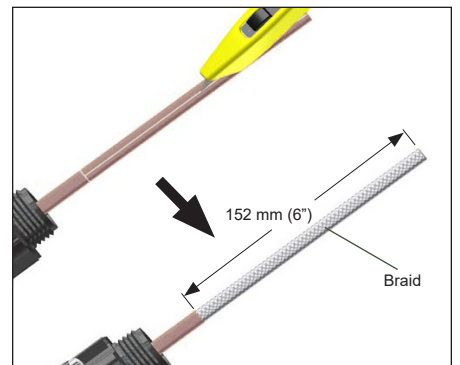

6. Cut and remove overjacket.

 **Do not cut metallic braid.**



7. Separate braid strands at edge of overjacket and pull trace heater through opening.



8. Twist braid into a pigtail. Trim ends of braid.

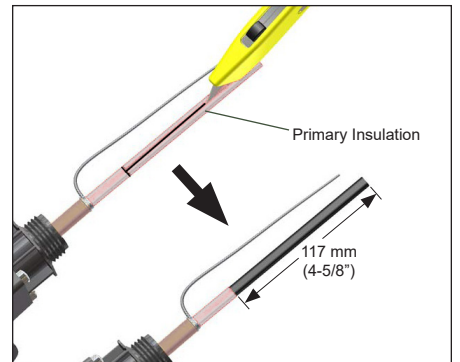

9. Cut and remove primary insulation jacket.

PCA-COM-D



10. Skive outside of black matrix.



Do not cut bus wire strands.

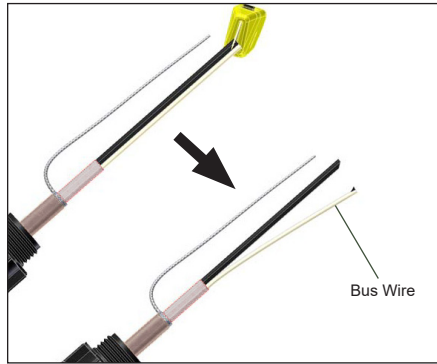

11. Cut V-Notch in matrix and pull bus wires from matrix. Cut and remove center matrix.



12. Apply a liberal amount of RTV sealant to trace heater.

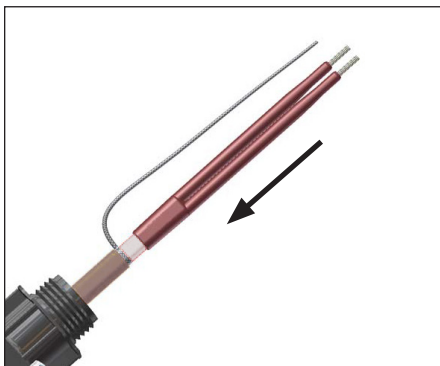

13. Slide boot onto the end of the trace heater.

End Termination for DLX and DSX

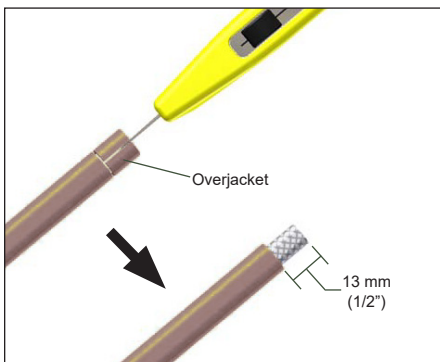

14. Cut and remove overjacket.

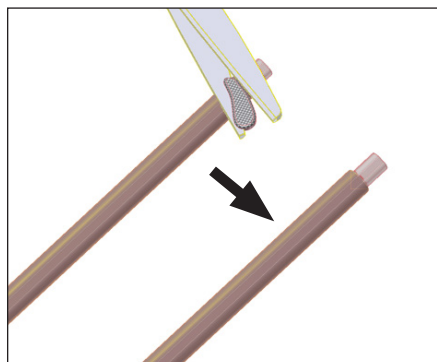

15. Trim ends of braid.

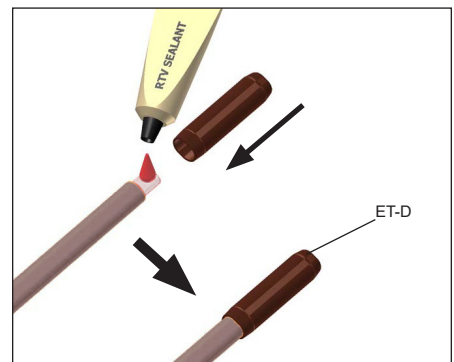

16. Apply a liberal amount of RTV sealant to trace heater and inside end cap. Slide end cap onto end of trace heater.

INSTALLATION PROCEDURES

Mount Junction Box and Make Connections

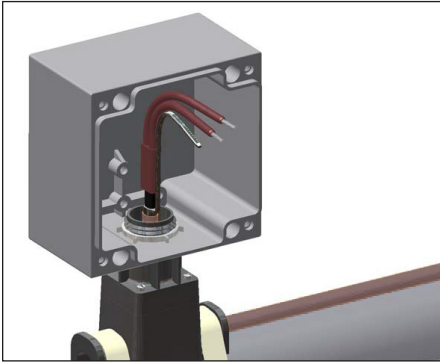

17. Mount junction box (Sold separately) on expediter using gasket and locknut provided.

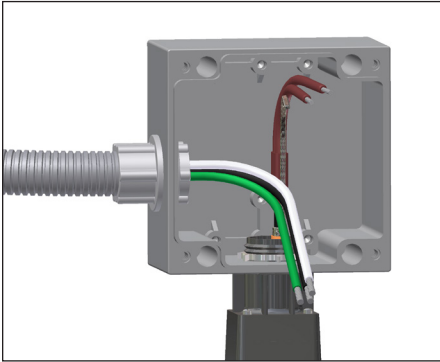

18. Install power connection fittings (supplied by others) and pull in power and ground wires.

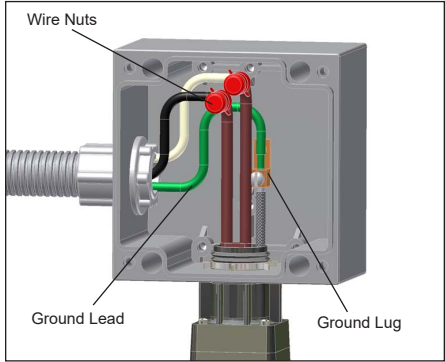

19. Complete system wiring. See typical wiring details below.

Typical Wiring Details

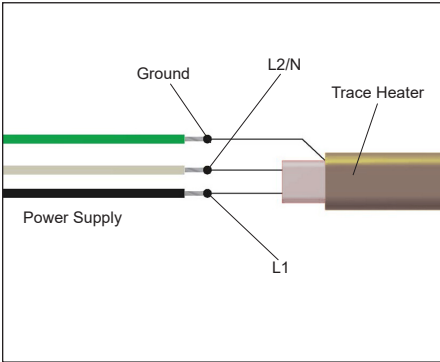

Power Connection-1 Trace heater.

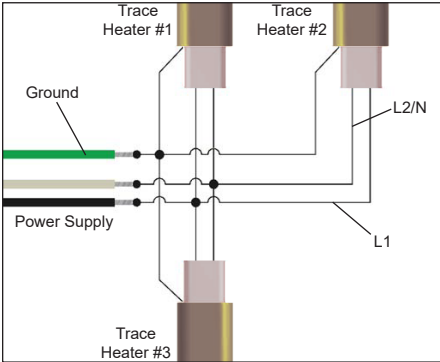

Power Connection-3 Trace heaters.

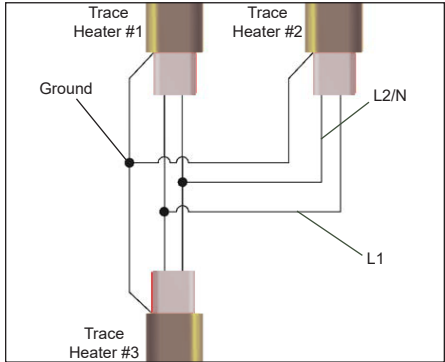

In-Line Splice and T-Splice

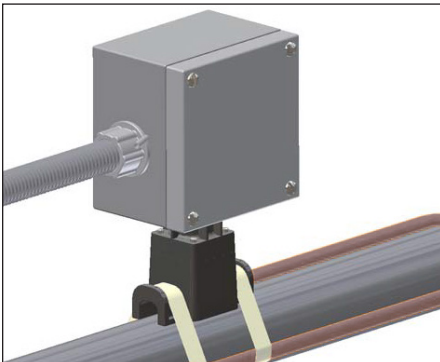

20. If using Thermon JB-K (sold separately) Install junction box lid using 4 captive screws.

PCA-COM-D

INSTALLATION PROCEDURES

Trace Heater Take-off for DLX and DSX

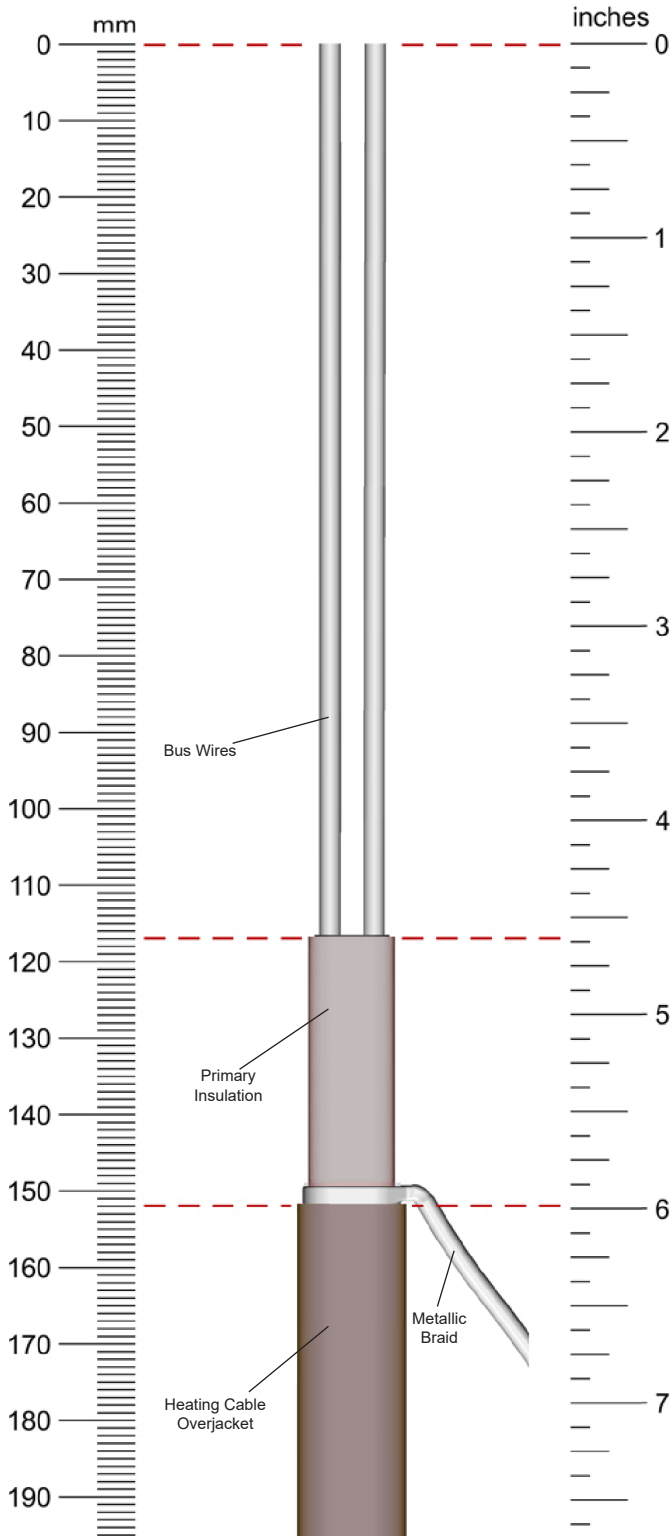

For Power Connector Boot Termination

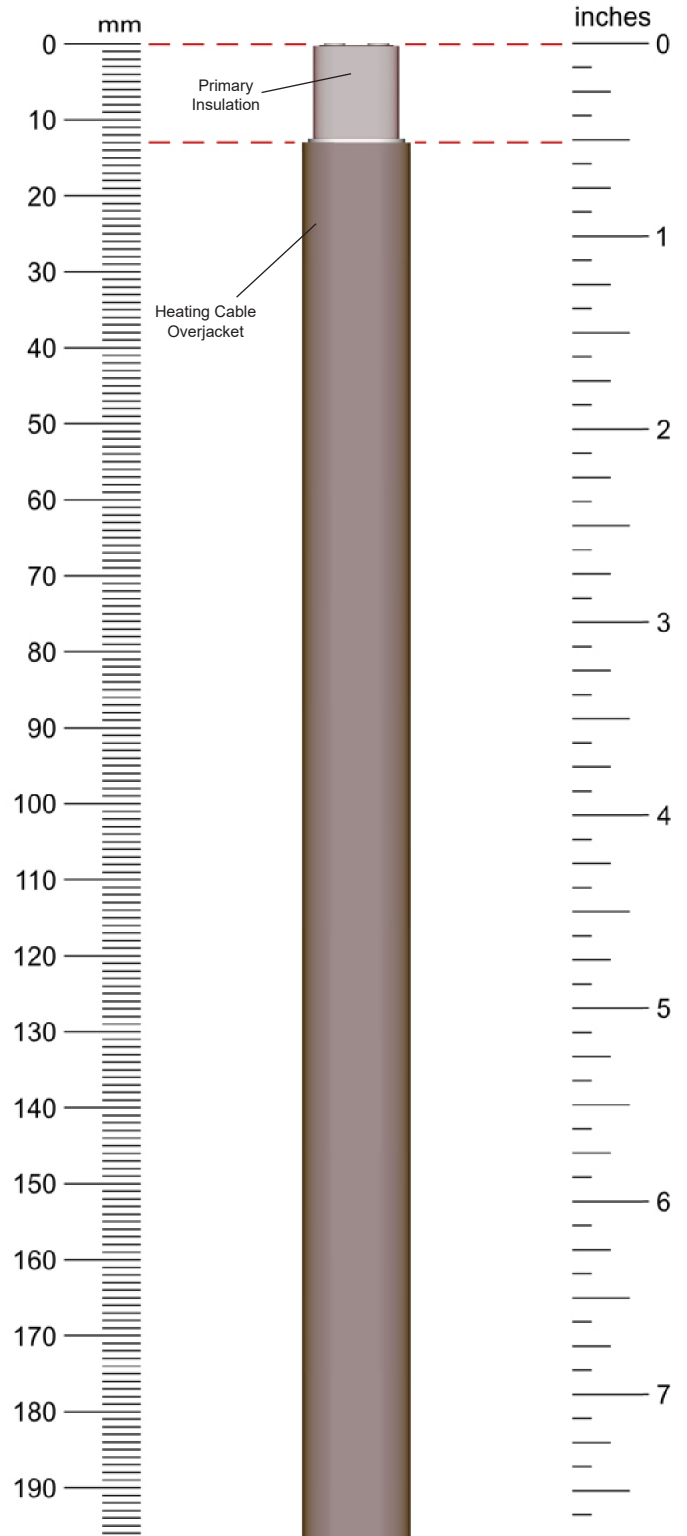

For End Cap Termination

NOTE: Images may not be printed to scale.

