

End Termination Kit Installation Instructions

Terminator DE-L

for use with RSX, TSX, VSX self-regulating heating cables

Terminator DE-S

for use with BSX*, HTSX, KSX self-regulating, HPT power-limiting,
and FP constant watt heating cables



For End Termination Applications
1-2 Cables - Standard
3 Cables - w/ Optional End Cap





* BSX self-regulating heating cables may also be used with Terminator DE-L

Item	Qty	Description
1	1	Splice Cap
2	1	Expediter Assembly Grommet Compressor Grommet Support Base w/ O-ring
3	1	Banding
4	1	Banding Guide
5	1	RTV Tube
6	2	End Caps
7	2	Tape Strips (DE-S kit only)
8	1	Optional End Cap - for 3 cable installations - not provided in kit

Tools Required



Certifications/Approvals



IP66 NEMA/Type 4X $-60^{\circ}\text{C} \leq T_a \leq +55^{\circ}\text{C}$
Ordinary & Hazardous Locations
Class I, Division 2, Groups A, B, C, & D, Zone 2 IIC

Class II, Division 2, Groups F & G, Class III
Listed Heat Tracing Cable System 137M

Warnings

- Due to the risk of electrical shock, arcing and fire caused by product damage or improper usage, installation or maintenance, a ground-fault protection device is required.
- Installation must comply with Thermon requirements and be installed in accordance with the NEC, CEC, or any other applicable national and local codes.

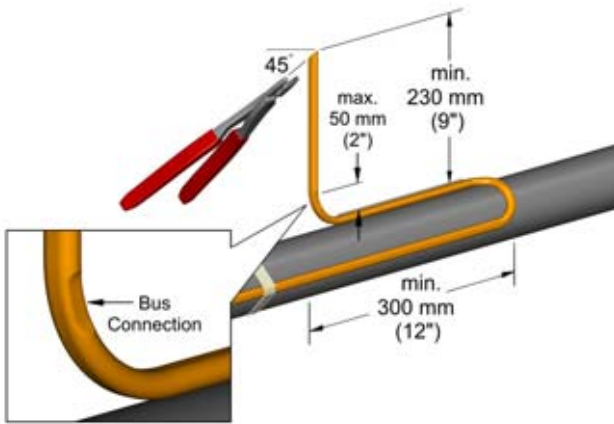
- Component approvals and performance ratings are based on the use of Thermon specified parts only.
- De-energize all power sources before opening enclosure.
- Keep ends of heating cable and kit components dry before and during installation.





1. Locate bus connection (HPT and FP only) and cable as shown. Cut end of cable at angle to aid in piercing grommet. Leave additional cable for expansion loop. See pages 7-8 for multiple cable installation tips.

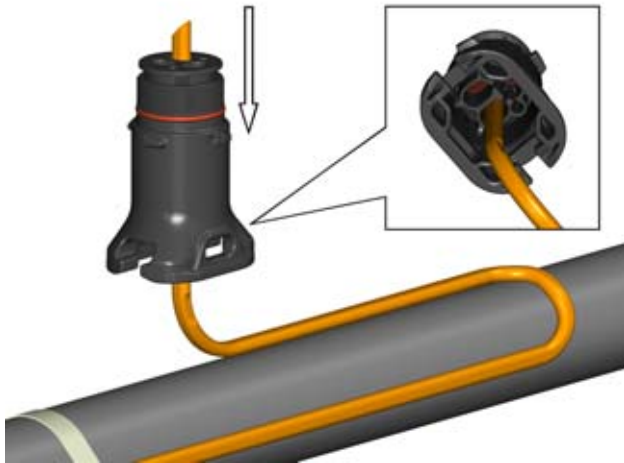

2. Insert cable into expediter. If mounted on bottom of pipe, punch out weep hole.

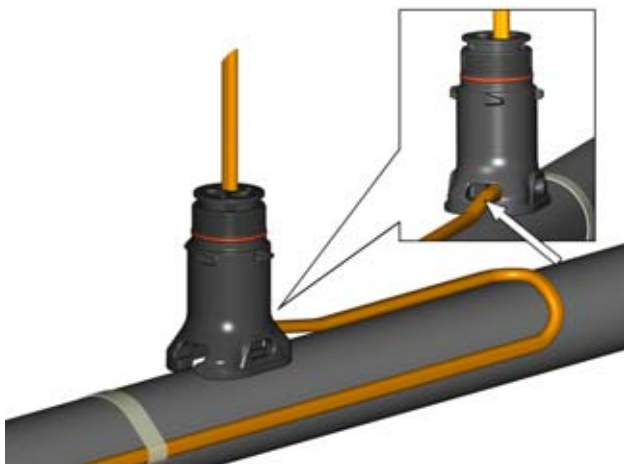

3. Slide expediter toward pipe and route cable through support base entry.

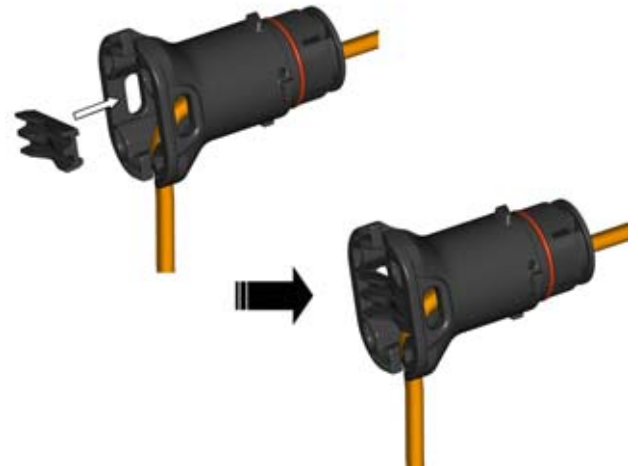

4. Insert banding guide into expediter and snap into place.

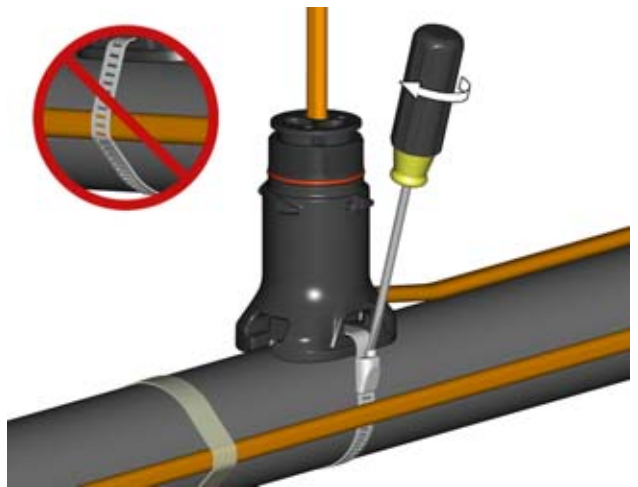

5. Mount expediter to pipe using pipe band. Do not band over cable.

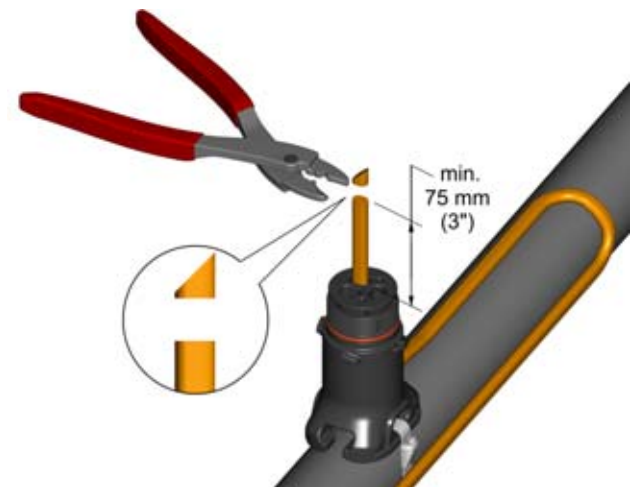

6. Cut off end of cable.



7. Terminate cable using cable termination (for BSX, HTSX, KSX, RSX, TSX, and VSX) on pages 9-10 or cable termination (for HPT and FP) on pages 11-14.



10. To remove cap, lift latch mechanism and unscrew cap.



8. Push excess cable back through expediter. Tighten cap securely. Tape cable expansion loop to pipe.



9. Completed end termination kit. Make sure latch mechanism is in the locked position.

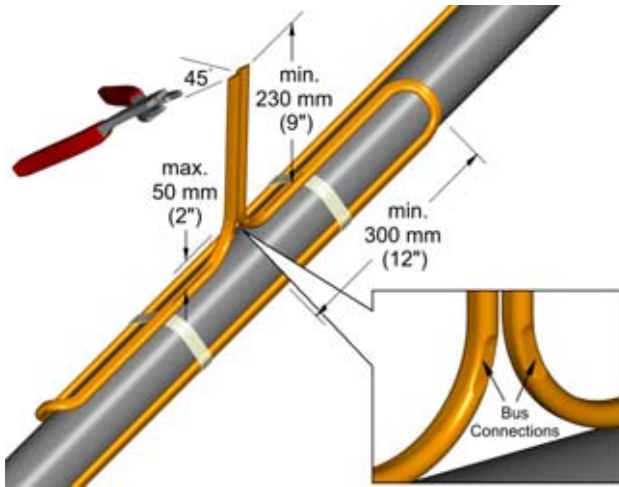

A1. Locate bus connection (HPT and FP only) and cable as shown. Cut end of cable at angle to aid in piercing grommet. Leave additional cable for expansion loop.

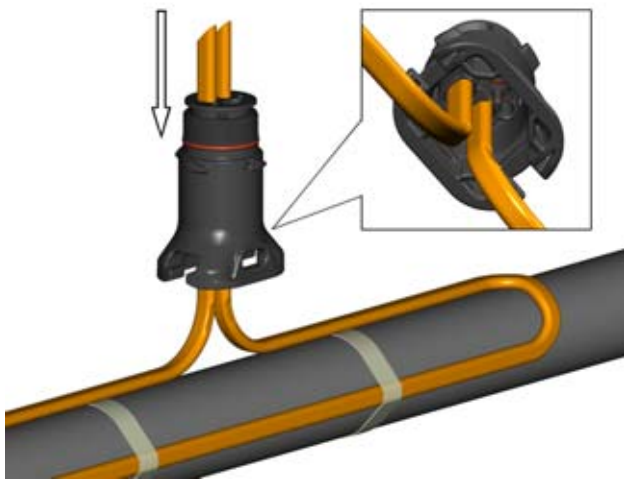

A2. Insert two cables into expediter.

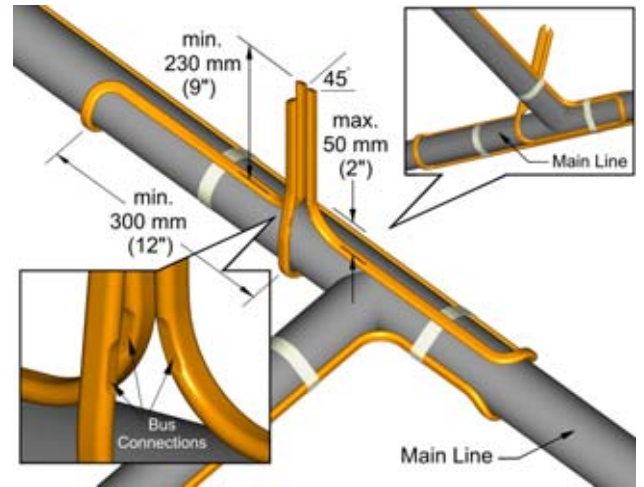

B1. Locate bus connection (HPT and FP only) and cable as shown. Cut end of cable at angle to aid in piercing grommet. Leave additional cable for expansion loop.

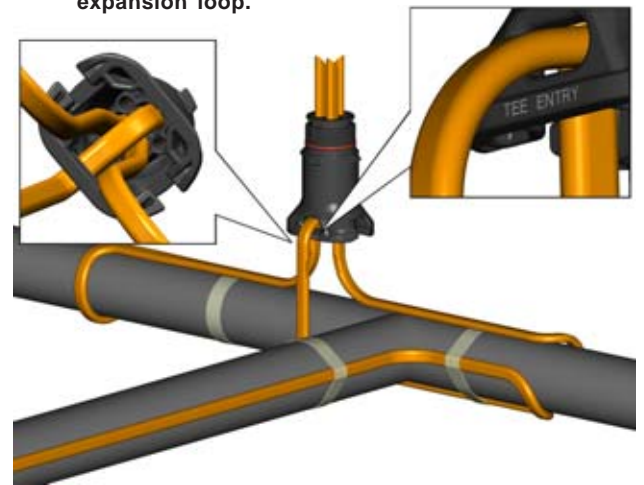

B2. Insert three cables into expediter.

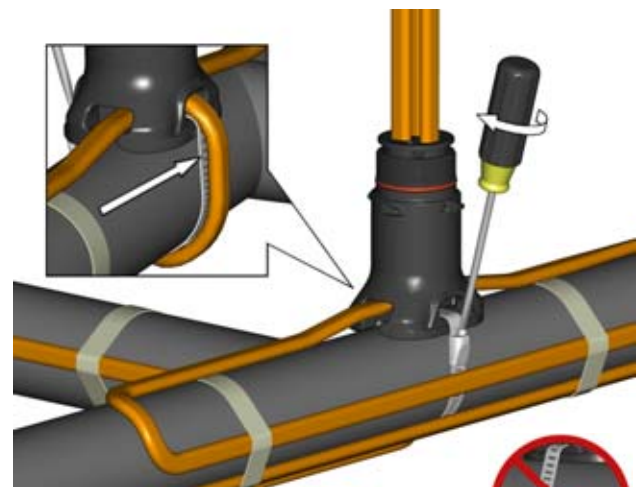

B3. Mount expediter with three cables. Do not band over cable.

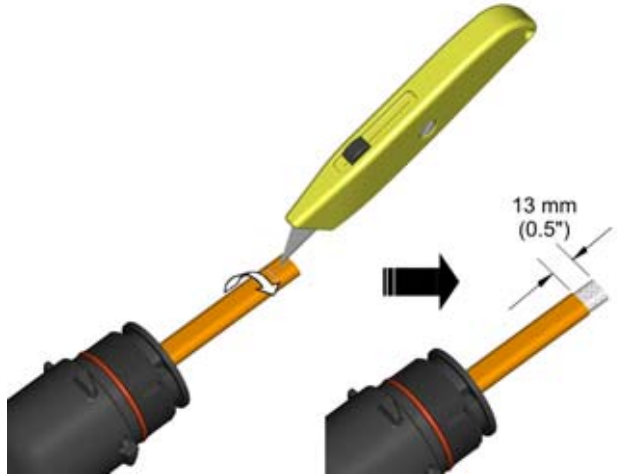

C1. Cut and remove overjacket.

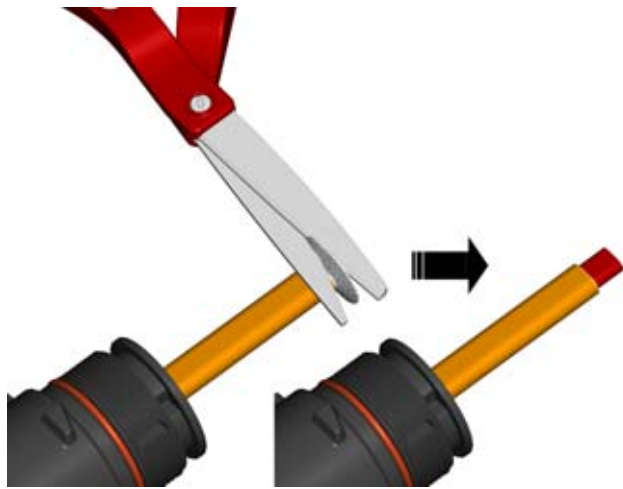

C2. Trim away exposed braid from cable.



C3. Apply a liberal amount of RTV sealant to cable and slide end cap onto the end of the cable.

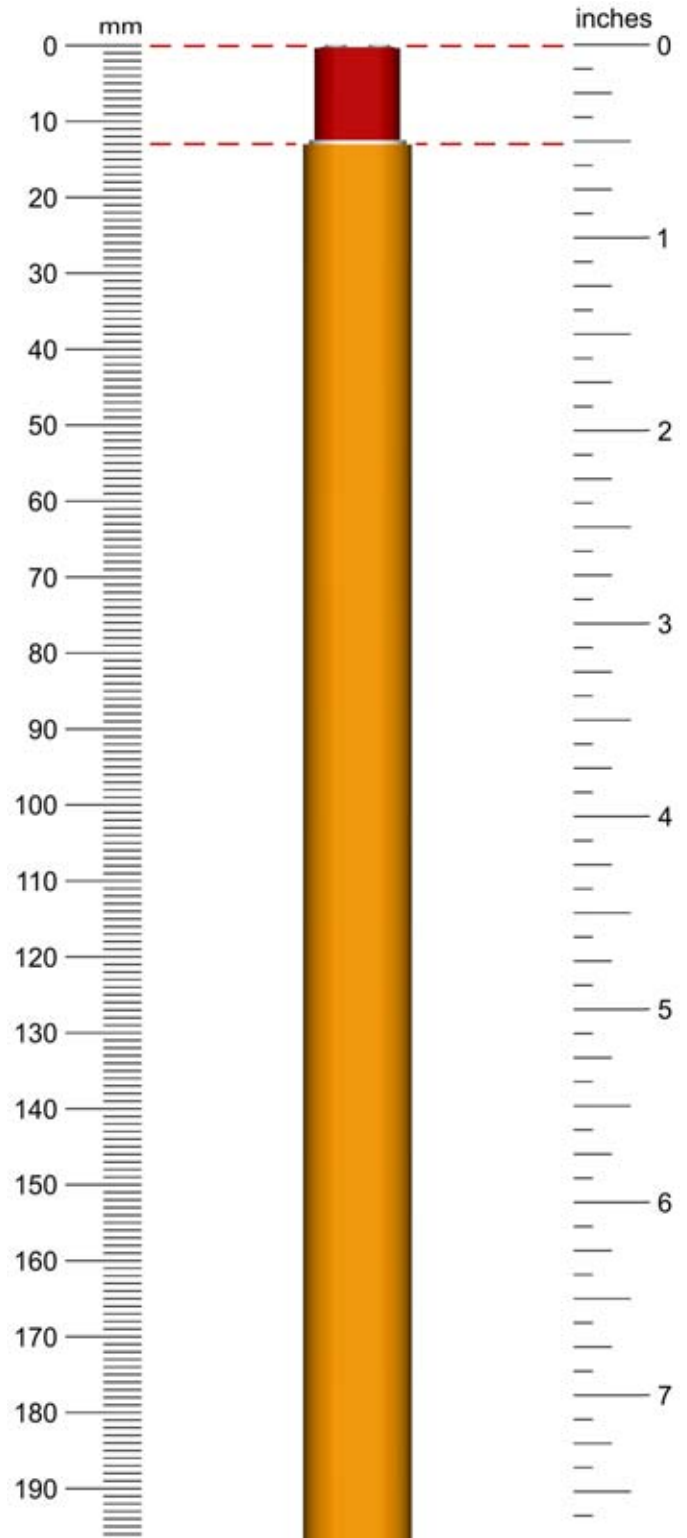

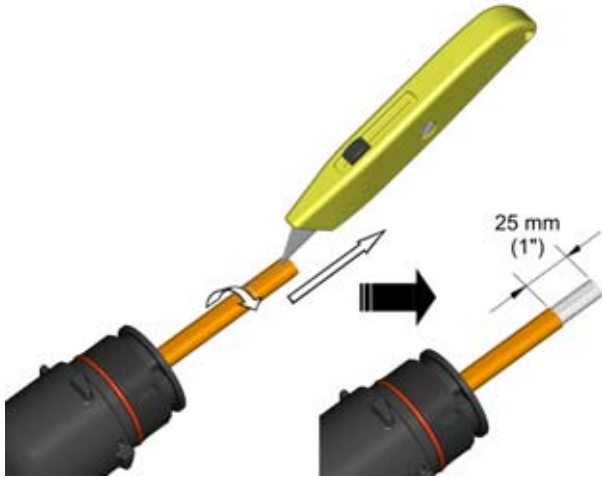

D1. Cut and remove overjacket.

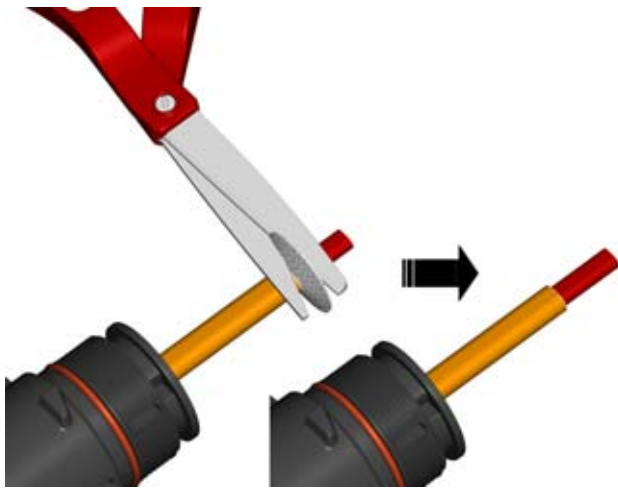

D2. Trim away exposed braid from cable.

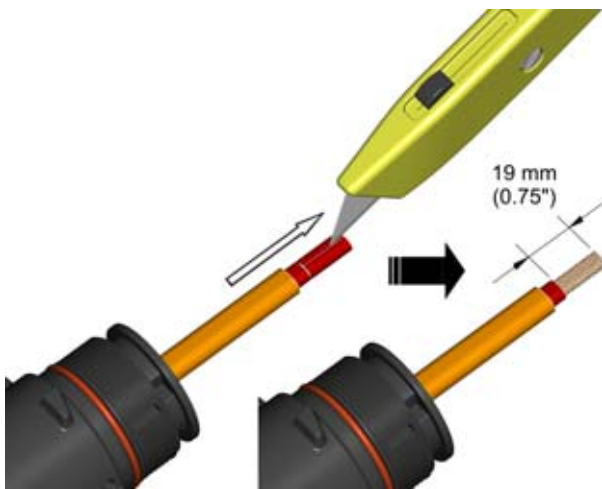

D3. Cut and remove primary insulation jacket.

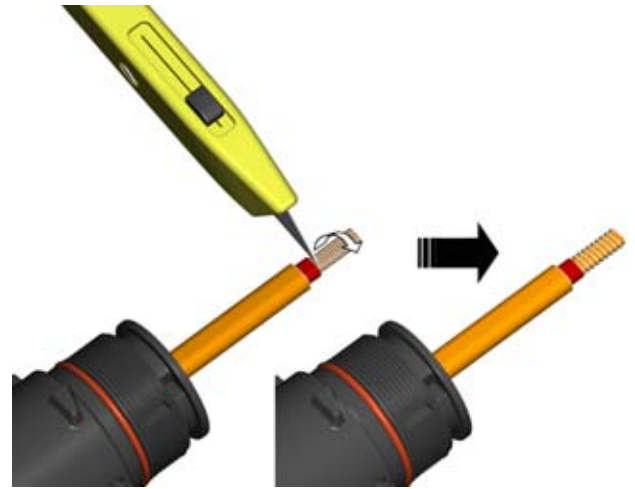

D4. Cut and remove fiberglass braid. Omit this step for FP cable.

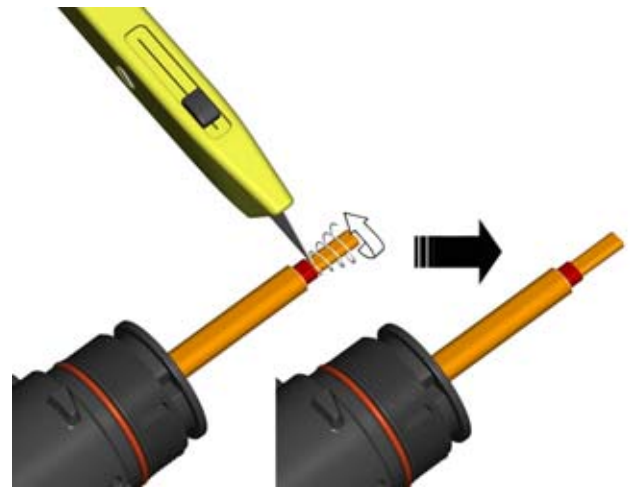

D5. Cut and remove heating element and fiberglass overlay (FP cable only). Push any remaining heating element wire under the primary insulation jacket.

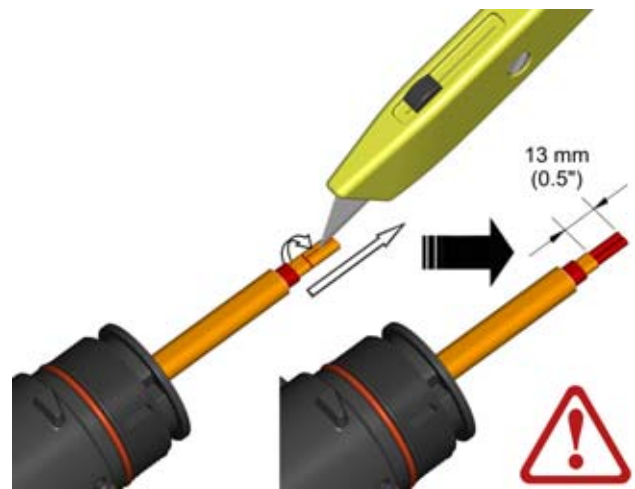

D6. Cut and remove pairing jacket. Do not cut bus wire insulation.

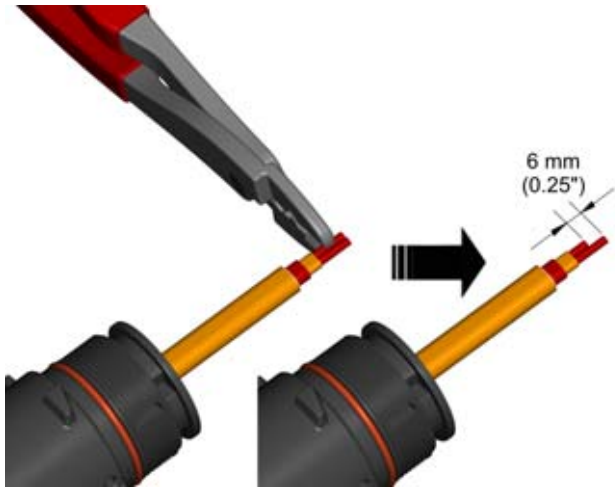

D7. Stagger cut one of the bus wires.

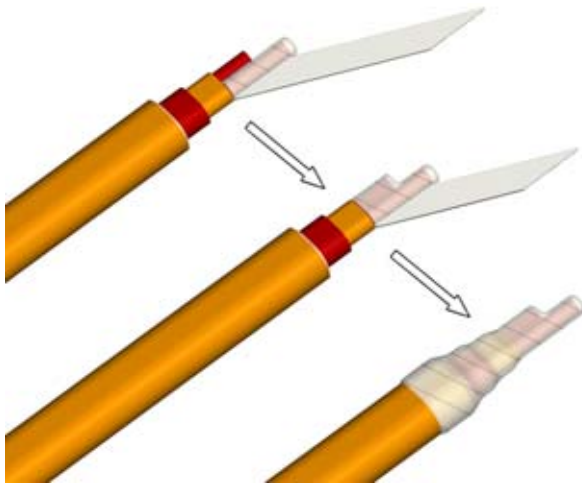

D8. Tape bus wires individually and then together. Continue taping to cover overjacket.

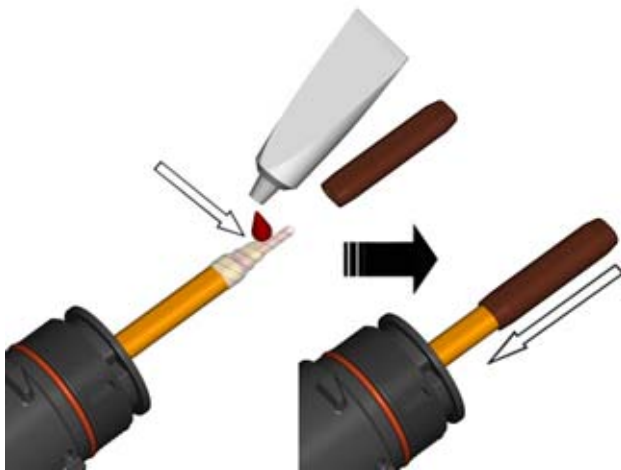

D9. Apply a liberal amount of RTV sealant to cable and slide end cap onto the end of the cable.

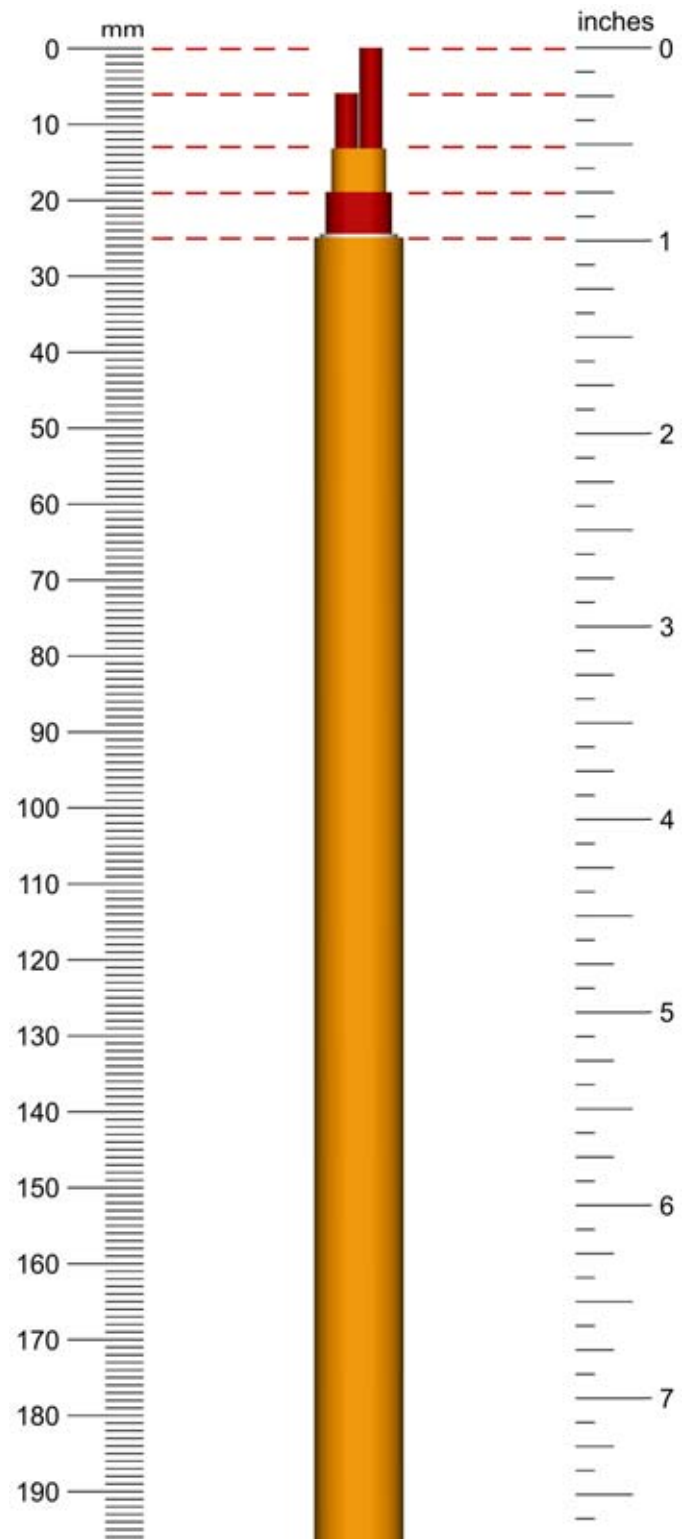

Form No. 50811 (04/28/05)



Thermon Manufacturing Company

100 Thermon Drive • P.O. Box 609 • San Marcos, Texas 78667-0609
Phone: (512) 396-5801 • Fax: (512) 396-3627 • 1-800-820-HEAT
www.thermon.com