



FLX™

Self-Regulating Heat Tracing

Commercial Winterization and Freeze Protection

DESIGN GUIDE

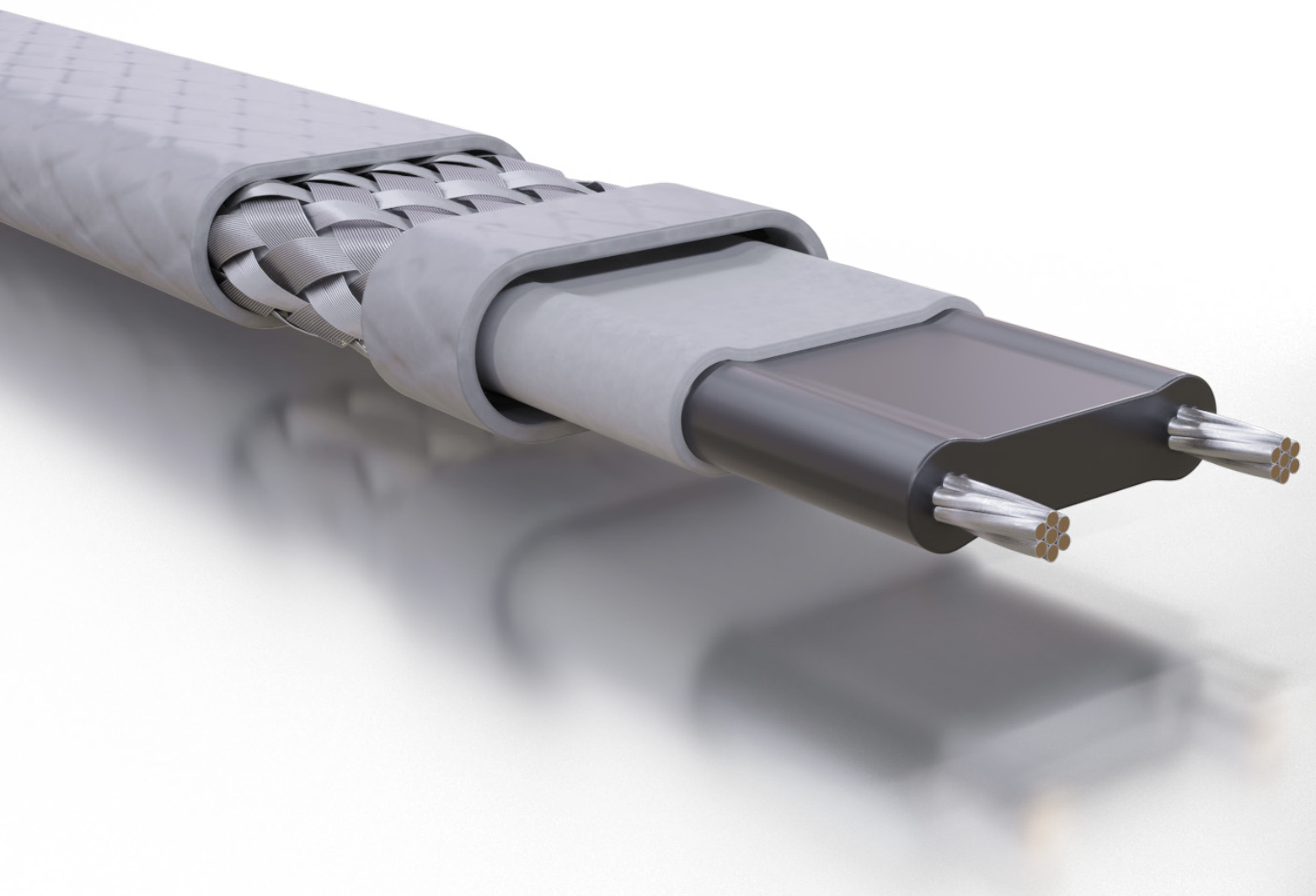



FLX™

Self-Regulating Heat Tracing
for Winterization/Freeze Protection

DESIGN GUIDE

Contents

Introduction	4
Application Information	4
Product Description	
Characteristics	
Freeze Protection Design Outline	5
Basis for a Good Design	
Step 1: Establish Design Parameters	5
Step 2: Select the Proper FLX Heat Trace	6-7
Step 3: Determine FLX Circuit Lengths	8
Step 4: Choose FLX Options	9
Step 5: Choose FLX Installation Accessories.....	10
Installation Guidelines for Fire Protection Systems	11
Design Worksheet	12
Design Tips	13
General Specification	14

For additional information about freeze protection of piping with heat tracing, please review the FLX product specification sheet (Thermon Form CPD1007) and the systems accessories sheet (Thermon Form CPD1017).

Contact Thermon for additional information.

FLX™ Self-Regulating Heat Tracing

Introduction

While an insulated pipe can withstand cold temperatures longer than an uninsulated pipe, the contents of the pipe will cool to the temperature of the surrounding environment. When the ambient temperature is below freezing, the results can be both costly and inconvenient. FLX self-regulating heat trace is designed to provide freeze protection of metallic and nonmetallic pipes, tanks and equipment by replacing the heat lost through the thermal insulation into the air.

Whether the application is a small project or a complex network of piping and equipment, designing an electric heat-traced freeze protection system is easy with FLX. The information contained in this design guide will take the reader through a step-by-step procedure to make proper heat trace selections based on:

- Minimum ambient temperature
- Heat trace start-up temperature
- Pipe size
- Thermal insulation type and thickness
- Available power supply

After following the prescribed steps in this design guide, the reader will be able to design, specify or establish a bill of materials for a freeze protection heat tracing system. If higher maintain temperatures are required contact Thermon for additional information.

Characteristics

Bus wire	1.3 mm ² (16 AWG) nickel-plated copper
Metallic braid	tinned copper
Outer jacket	-OJ, polyolefin; -FOJ, fluoropolymer
Minimum bend radius	
@ 5°F (-15°C)	10 mm (0.38")
@ -76°F (-60°C)	32 mm (1.25")
Supply voltage	110-120 or 208-277 Vac
Circuit protection	30 mA ground-fault protection required
Max. operating temperature (power-on)	65°C (150°F)
Max. exposure temperature (power-off)	85°C (185°F)
Minimum installation temperature	-51°C (-60°F)

Product Description

FLX self-regulating heat trace varies its heat output to compensate for the surrounding conditions along the entire length of a circuit. Whenever the heat loss of the insulated pipe, tank or equipment increases (as ambient temperature drops), the heat output of the heat trace increases. Conversely, when the heat loss decreases (as ambient temperature rises), the heat trace reacts by reducing its heat output. This self-regulating feature occurs along the entire length of a heat tracing circuit to ensure each point receives the required amount of heat while conserving energy. FLX is rated for nominal heat outputs of 10, 16, 26 and 33 W/m at 10°C (3, 5, 8 and 10 W/ft at 50°F) when powered at 110 to 120 Vac or 208 to 277 Vac. FLX self-regulating trace heaters are protected by a tinned copper braid and a polyolefin outer jacket to provide grounding and additional mechanical protection for the heat trace. An optional fluoropolymer outer jacket is available if additional environmental protection is required.

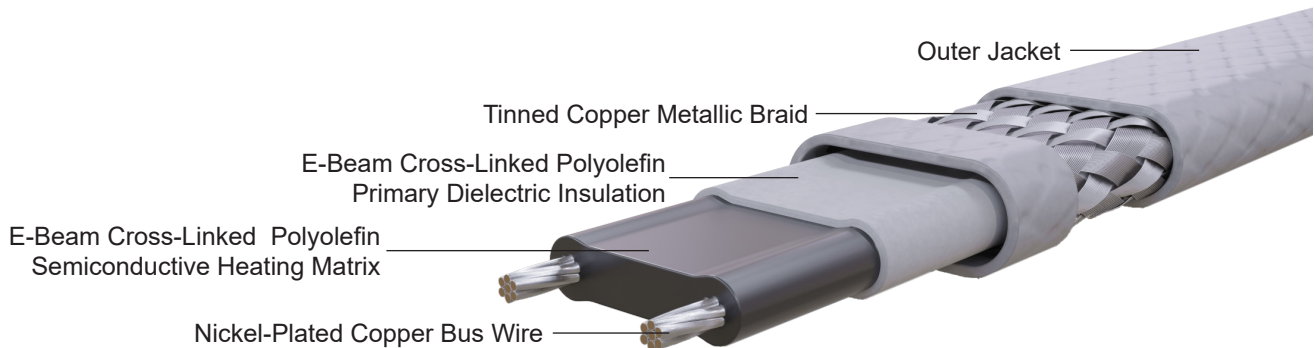

Freeze Protection Design Outline

The following steps outline the design and selection process for an FLX self-regulating freeze protection system:

Step 1: Establish Design Parameters

Collect relevant project data:

- a. Piping/equipment
 - Diameter
 - Length
 - Material
- b. Temperatures
 - Minimum ambient
 - Maintain temperature
 - Start-up temperature
- c. Insulation
 - Type
 - Thickness
- d. Electrical
 - Supply voltage
 - Circuit breaker size

Step 2: Select the Proper FLX Heat Trace

Using information gathered in Step 1:

- a. For metallic piping, use Design Chart 2.1
- b. For nonmetallic piping, use Design Chart 2.2

Step 3: Determine FLX Circuit Lengths

Based on:

- a. Pipe lengths plus allowances for
 - Valves, pumps, other equipment
 - Pipe supports
 - Circuit fabrication and splice kits
- b. Electrical supply
 - Operating voltage
 - Available branch circuit breaker sizes
- c. FLX selection parameters
 - Start-up temperature
 - Maximum FLX circuit lengths

Step 4: Choose FLX Options

Metallic braid and a polyolefin outer jacket are standard; options include:

- a. Fluoropolymer outer jacket

Step 5: Choose FLX Installation Accessories

Minimum accessories include:

- a. Circuit fabrication kit
- b. Fixing tape

The step-by-step procedures which follow will provide the reader with the detailed information required to design, select and/or specify a fully functional electric heat tracing system.

Basis for a Good Design

The generally accepted maintenance temperature for freeze protection is 4°C (40°F). This design guide is based on that temperature and provides a safety zone to protect the piping and the contents from freezing.

To become familiar with the requirements of a properly designed electric heat tracing freeze protection system, use the five design steps detailed here and on the following pages. Once comfortable with the steps and the information required, use the design worksheet included at the end of this design guide for applying these steps to a freeze protection heat tracing application.

Step 1: Establish Design Parameters

Collect information relative to the following design parameters:

Application Information

- Pipe sizes or tubing diameters
- Pipe lengths
- Pipe material (metallic or nonmetallic)
- Type and number of valves, pumps or other equipment
- Type and number of pipe supports

Expected Minimum Ambient Temperature

Generally, this number is obtained from weather data compiled for an area and is based on recorded historical data. There are times, however, when the minimum ambient will be a number other than the minimum outside air temperature. Piping located inside of unheated buildings or in unconditioned attics may be subject to freezing but may have different minimum ambients.

Minimum Start-Up Temperature This temperature differs from the minimum expected ambient in that the heat trace will typically be energized at a higher ambient temperature. This temperature will have an effect on the maximum circuit length and circuit breaker sizing for a given application (see Table 3.3 or 3.4 on page 9).

Insulation Material and Thickness The selection charts in this design guide are based on fiberglass insulation with thicknesses shown in Design Selection Charts 2.1 and 2.2. If insulation materials other than fiberglass are used, contact a Thermon factory representative for a design selection chart supplement that corresponds with the insulation material.

Supply Voltage FLX self-regulating heat trace is designed in two voltage groups: 110-120 Vac and 208-277 Vac. Determine what voltage(s) are available at a facility for use with heat tracing.





FLX™ Self-Regulating Heat Tracing

Step 2: Select the Proper FLX Heat Trace

Using the pipe diameter, insulation thickness and minimum expected ambient, find the recommended heat trace using Design Selection Chart 2.1 Metallic Piping, at right, or Design Selection Chart 2.2 Nonmetallic Piping on page 7.

All heat trace selection is based on fiberglass insulation. Closed-cell flexible foam insulation of the same thickness may also be used. If the pipe size or insulation information does not appear, contact Thermon or a Thermon factory representative.

1. Select the vertical column headed by a low ambient temperature which is equal to or lower than that expected.
2. Use the table section which corresponds to the pipe insulation thickness shown in the left-hand column.
3. Based on the pipe diameter(s) for the application, read across the table to the low ambient temperature and note the FLX recommended for that set of conditions.
4. Note that larger pipe sizes and lower ambient temperatures may require multiple passes of heat trace.
5. On piping with a diameter of DN32 (1¼") and smaller, the insulation must be one pipe size larger to accommodate the heat trace; i.e., use insulation sized for a DN25 (1") diameter pipe if the pipe to be insulated is DN20 (¾") in diameter.
6. For pipe sizes larger than listed or for maintain temperatures other than 4°C (40°F), contact Thermon or a Thermon factory representative.

	One Pass 3-FLX
	One Pass 5-FLX
	One Pass 8-FLX
	One Pass 10-FLX
	Contact Thermon

Design Selection Chart 2.1 Metallic Piping





Insulation Thickness mm (in)	Pipe Size DN (NPS)	Low Ambient Temperature				
		-12°C (+10°F)	-18°C (0°F)	-23°C (-10°F)	-29°C (-20°F)	-40°C (-40°F)
13 (½)	15 (½")	One Pass 3-FLX	One Pass 3-FLX	One Pass 3-FLX	One Pass 3-FLX	One Pass 3-FLX
	20 (¾")	One Pass 3-FLX	One Pass 3-FLX	One Pass 3-FLX	One Pass 3-FLX	One Pass 3-FLX
	25 (1")	One Pass 3-FLX	One Pass 3-FLX	One Pass 3-FLX	One Pass 5-FLX	One Pass 5-FLX
	32 (1¼")	One Pass 3-FLX	One Pass 3-FLX	One Pass 5-FLX	One Pass 5-FLX	One Pass 5-FLX
	40 (1½")	One Pass 3-FLX	One Pass 3-FLX	One Pass 5-FLX	One Pass 5-FLX	One Pass 8-FLX
	50 (2")	One Pass 3-FLX	One Pass 3-FLX	One Pass 5-FLX	One Pass 8-FLX	One Pass 8-FLX
	65 (2½")	One Pass 3-FLX	One Pass 5-FLX	One Pass 5-FLX	One Pass 8-FLX	One Pass 10-FLX
	80 (3")	One Pass 5-FLX	One Pass 5-FLX	One Pass 8-FLX	Contact Thermon	Contact Thermon
	100 (4")	One Pass 5-FLX	One Pass 8-FLX	Contact Thermon	Contact Thermon	Contact Thermon
	150 (6")	Contact Thermon	Contact Thermon	Contact Thermon	Contact Thermon	Contact Thermon
25 (1)	≤ 20 (¾")	One Pass 3-FLX	One Pass 3-FLX	One Pass 3-FLX	One Pass 3-FLX	One Pass 3-FLX
	25 (1")	One Pass 3-FLX	One Pass 3-FLX	One Pass 3-FLX	One Pass 3-FLX	One Pass 3-FLX
	32 (1¼")	One Pass 3-FLX	One Pass 3-FLX	One Pass 3-FLX	One Pass 3-FLX	One Pass 3-FLX
	40 (1½")	One Pass 3-FLX	One Pass 3-FLX	One Pass 3-FLX	One Pass 3-FLX	One Pass 3-FLX
	50 (2")	One Pass 3-FLX	One Pass 3-FLX	One Pass 3-FLX	One Pass 5-FLX	One Pass 5-FLX
	65 (2½")	One Pass 3-FLX	One Pass 3-FLX	One Pass 5-FLX	One Pass 5-FLX	One Pass 5-FLX
	80 (3")	One Pass 3-FLX	One Pass 5-FLX	One Pass 5-FLX	One Pass 8-FLX	One Pass 8-FLX
	100 (4")	One Pass 5-FLX	One Pass 5-FLX	One Pass 8-FLX	One Pass 8-FLX	One Pass 8-FLX
	150 (6")	One Pass 5-FLX	One Pass 8-FLX	Contact Thermon	Contact Thermon	Contact Thermon
	200 (8")	One Pass 8-FLX	Contact Thermon	Contact Thermon	Contact Thermon	Contact Thermon
38 (1½)	250 (10")	One Pass 8-FLX	Contact Thermon	Contact Thermon	Contact Thermon	Contact Thermon
	300 (12")	Contact Thermon	Contact Thermon	Contact Thermon	Contact Thermon	Contact Thermon
	350 (14")	Contact Thermon	Contact Thermon	Contact Thermon	Contact Thermon	Contact Thermon
	≤ 25 (1")	One Pass 3-FLX	One Pass 3-FLX	One Pass 3-FLX	One Pass 3-FLX	One Pass 3-FLX
	32 (1¼")	One Pass 3-FLX	One Pass 3-FLX	One Pass 3-FLX	One Pass 3-FLX	One Pass 3-FLX
	40 (1½")	One Pass 3-FLX	One Pass 3-FLX	One Pass 3-FLX	One Pass 3-FLX	One Pass 3-FLX
	50 (2")	One Pass 3-FLX	One Pass 3-FLX	One Pass 3-FLX	One Pass 3-FLX	One Pass 3-FLX
	65 (2½")	One Pass 3-FLX	One Pass 3-FLX	One Pass 3-FLX	One Pass 5-FLX	One Pass 5-FLX
	80 (3")	One Pass 3-FLX	One Pass 3-FLX	One Pass 5-FLX	One Pass 5-FLX	One Pass 5-FLX
	100 (4")	One Pass 3-FLX	One Pass 5-FLX	One Pass 5-FLX	One Pass 8-FLX	One Pass 8-FLX
50 (2)	150 (6")	One Pass 5-FLX	One Pass 5-FLX	One Pass 8-FLX	One Pass 8-FLX	One Pass 8-FLX
	200 (8")	One Pass 5-FLX	One Pass 8-FLX	One Pass 8-FLX	One Pass 10-FLX	One Pass 10-FLX
	250 (10")	One Pass 8-FLX	One Pass 8-FLX	One Pass 10-FLX	Contact Thermon	Contact Thermon
	300 (12")	One Pass 8-FLX	One Pass 10-FLX	Contact Thermon	Contact Thermon	Contact Thermon
	350 (14")	Contact Thermon	Contact Thermon	Contact Thermon	Contact Thermon	Contact Thermon
	≤ 25 (1")	One Pass 3-FLX	One Pass 3-FLX	One Pass 3-FLX	One Pass 3-FLX	One Pass 3-FLX
	32 (1¼")	One Pass 3-FLX	One Pass 3-FLX	One Pass 3-FLX	One Pass 3-FLX	One Pass 3-FLX
	40 (1½")	One Pass 3-FLX	One Pass 3-FLX	One Pass 3-FLX	One Pass 3-FLX	One Pass 3-FLX
	50 (2")	One Pass 3-FLX	One Pass 3-FLX	One Pass 3-FLX	One Pass 3-FLX	One Pass 3-FLX
	65 (2½")	One Pass 3-FLX	One Pass 3-FLX	One Pass 3-FLX	One Pass 5-FLX	One Pass 5-FLX

Design Selection Chart 2.2 Nonmetallic Piping

Insulation Thickness mm (in)	Pipe Size DN (NPS)	Low Ambient Temperature				
		-12°C (+10°F)	-18°C (0°F)	-23°C (-10°F)	-29°C (-20°F)	-40°C (-40°F)
13 (½)	15 (½")	One Pass 3-FLX	One Pass 3-FLX	One Pass 3-FLX	One Pass 3-FLX	One Pass 3-FLX
	20 (¾")	One Pass 3-FLX	One Pass 3-FLX	One Pass 3-FLX	One Pass 3-FLX	One Pass 3-FLX
	25 (1")	One Pass 3-FLX	One Pass 3-FLX	One Pass 3-FLX	One Pass 3-FLX	One Pass 3-FLX
	32 (1¼")	One Pass 3-FLX	One Pass 3-FLX	One Pass 3-FLX	One Pass 3-FLX	One Pass 3-FLX
	40 (1½")	One Pass 3-FLX	One Pass 3-FLX	One Pass 3-FLX	One Pass 3-FLX	One Pass 3-FLX
	50 (2")	One Pass 3-FLX	One Pass 3-FLX	One Pass 3-FLX	One Pass 3-FLX	One Pass 3-FLX
	65 (2½")	One Pass 3-FLX	One Pass 3-FLX	One Pass 3-FLX	One Pass 3-FLX	One Pass 3-FLX
	80 (3")	One Pass 3-FLX	One Pass 3-FLX	One Pass 3-FLX	One Pass 3-FLX	One Pass 3-FLX
	100 (4")	One Pass 3-FLX	One Pass 3-FLX	One Pass 3-FLX	One Pass 3-FLX	One Pass 3-FLX
25 (1)	≤ 20 (¾")	One Pass 3-FLX	One Pass 3-FLX	One Pass 3-FLX	One Pass 3-FLX	One Pass 3-FLX
	25 (1")	One Pass 3-FLX	One Pass 3-FLX	One Pass 3-FLX	One Pass 3-FLX	One Pass 3-FLX
	32 (1¼")	One Pass 3-FLX	One Pass 3-FLX	One Pass 3-FLX	One Pass 3-FLX	One Pass 3-FLX
	40 (1½")	One Pass 3-FLX	One Pass 3-FLX	One Pass 3-FLX	One Pass 3-FLX	One Pass 3-FLX
	50 (2")	One Pass 3-FLX	One Pass 3-FLX	One Pass 3-FLX	One Pass 3-FLX	One Pass 3-FLX
	65 (2½")	One Pass 3-FLX	One Pass 3-FLX	One Pass 3-FLX	One Pass 3-FLX	One Pass 3-FLX
	80 (3")	One Pass 3-FLX	One Pass 3-FLX	One Pass 3-FLX	One Pass 3-FLX	One Pass 3-FLX
	100 (4")	One Pass 3-FLX	One Pass 3-FLX	One Pass 3-FLX	One Pass 3-FLX	One Pass 3-FLX
	150 (6")	One Pass 3-FLX	One Pass 3-FLX	One Pass 3-FLX	One Pass 3-FLX	One Pass 3-FLX
	200 (8")	One Pass 3-FLX	One Pass 3-FLX	One Pass 3-FLX	One Pass 3-FLX	One Pass 3-FLX
	250 (10")	One Pass 3-FLX	One Pass 3-FLX	One Pass 3-FLX	One Pass 3-FLX	One Pass 3-FLX
	300 (12")	One Pass 3-FLX	One Pass 3-FLX	One Pass 3-FLX	One Pass 3-FLX	One Pass 3-FLX
	350 (14")	One Pass 3-FLX	One Pass 3-FLX	One Pass 3-FLX	One Pass 3-FLX	One Pass 3-FLX
38 (1½)	≤ 25 (1")	One Pass 3-FLX	One Pass 3-FLX	One Pass 3-FLX	One Pass 3-FLX	One Pass 3-FLX
	32 (1¼")	One Pass 3-FLX	One Pass 3-FLX	One Pass 3-FLX	One Pass 3-FLX	One Pass 3-FLX
	40 (1½")	One Pass 3-FLX	One Pass 3-FLX	One Pass 3-FLX	One Pass 3-FLX	One Pass 3-FLX
	50 (2")	One Pass 3-FLX	One Pass 3-FLX	One Pass 3-FLX	One Pass 3-FLX	One Pass 3-FLX
	65 (2½")	One Pass 3-FLX	One Pass 3-FLX	One Pass 3-FLX	One Pass 3-FLX	One Pass 3-FLX
	80 (3")	One Pass 3-FLX	One Pass 3-FLX	One Pass 3-FLX	One Pass 3-FLX	One Pass 3-FLX
	100 (4")	One Pass 3-FLX	One Pass 3-FLX	One Pass 3-FLX	One Pass 3-FLX	One Pass 3-FLX
	150 (6")	One Pass 3-FLX	One Pass 3-FLX	One Pass 3-FLX	One Pass 3-FLX	One Pass 3-FLX
	200 (8")	One Pass 3-FLX	One Pass 3-FLX	One Pass 3-FLX	One Pass 3-FLX	One Pass 3-FLX
	250 (10")	One Pass 3-FLX	One Pass 3-FLX	One Pass 3-FLX	One Pass 3-FLX	One Pass 3-FLX
	300 (12")	One Pass 3-FLX	One Pass 3-FLX	One Pass 3-FLX	One Pass 3-FLX	One Pass 3-FLX
	350 (14")	One Pass 3-FLX	One Pass 3-FLX	One Pass 3-FLX	One Pass 3-FLX	One Pass 3-FLX
	50 (2)	≤ 25 (1")	One Pass 3-FLX	One Pass 3-FLX	One Pass 3-FLX	One Pass 3-FLX
32 (1¼")		One Pass 3-FLX	One Pass 3-FLX	One Pass 3-FLX	One Pass 3-FLX	One Pass 3-FLX
40 (1½")		One Pass 3-FLX	One Pass 3-FLX	One Pass 3-FLX	One Pass 3-FLX	One Pass 3-FLX
50 (2")		One Pass 3-FLX	One Pass 3-FLX	One Pass 3-FLX	One Pass 3-FLX	One Pass 3-FLX
65 (2½")		One Pass 3-FLX	One Pass 3-FLX	One Pass 3-FLX	One Pass 3-FLX	One Pass 3-FLX
80 (3")		One Pass 3-FLX	One Pass 3-FLX	One Pass 3-FLX	One Pass 3-FLX	One Pass 3-FLX
100 (4")		One Pass 3-FLX	One Pass 3-FLX	One Pass 3-FLX	One Pass 3-FLX	One Pass 3-FLX
150 (6")		One Pass 3-FLX	One Pass 3-FLX	One Pass 3-FLX	One Pass 3-FLX	One Pass 3-FLX
200 (8")		One Pass 3-FLX	One Pass 3-FLX	One Pass 3-FLX	One Pass 3-FLX	One Pass 3-FLX
250 (10")		One Pass 3-FLX	One Pass 3-FLX	One Pass 3-FLX	One Pass 3-FLX	One Pass 3-FLX
300 (12")		One Pass 3-FLX	One Pass 3-FLX	One Pass 3-FLX	One Pass 3-FLX	One Pass 3-FLX
350 (14")		One Pass 3-FLX	One Pass 3-FLX	One Pass 3-FLX	One Pass 3-FLX	One Pass 3-FLX

Additional Considerations for Nonmetallic Piping For freeze protecting nonmetallic pipes, FLX is to be installed with a continuous covering of AL-20L foil tape. The data in Design Selection Chart 2.2 is based on this installation method.

Heat loss characteristics are similar to metal pipes, but the FLX self-regulating heat trace output is lower because of the insulating properties of the pipewall material. Design Selection Chart 2.2 reflects these values.

-  One Pass 3-FLX
-  One Pass 5-FLX
-  One Pass 8-FLX
-  One Pass 10-FLX
-  Contact Thermon

Note
Heat loss calculations in Chart 2.1 and 2.2 are based on IEC/IEEE 60079-30-2 Annex E, with the following provisions:

- Piping insulated with glass fiber in accordance with ASTM Std C547.
- Pipes located outdoors in ambient with a 40 km/h (25 mph) wind.
- A 10% safety factor has been included.

FLX™ Self-Regulating Heat Tracing

Step 3: Determine FLX Circuit Lengths

Heat tracing circuit lengths are based on several conditions which must be simultaneously taken into account and include:

- Length of piping (including extra allowances)
- Operating voltage
- Available branch circuit breaker sizes
- Expected start-up temperature
- Maximum allowable circuit lengths

Every heat tracing circuit will require some additional heat trace to make the various splices and terminations. Additional heat trace will also be needed to provide extra heat at valves, pumps, miscellaneous equipment and pipe supports. Use the following guidelines to determine the amount of extra heat trace required:

- **Power connections** Allow an additional .3 m (1') of FLX for each heating circuit.
- **In-line splices** Allow an additional .6 m (2') of FLX for each splice kit.
- **T-splices** Allow an additional 1 m (3') of FLX for each splice kit.
- **Pipe supports** Insulated pipe supports require no additional heat trace. For uninsulated supports, allow two times the length of the pipe support plus an additional 38 cm (15") of heat trace.
- **Valves and pumps** Use allowances from Tables 3.1 and 3.2.

To determine circuit lengths, a voltage selection must be made from the available voltages gathered as part of Step 1. In Step 2 the proper FLX (3, 5, 8 or 10) was selected from Design Selection Chart 2.1 or 2.2. Using voltage and heat trace selections plus Table 3.3 or 3.4 the maximum heat trace lengths and branch circuit breaker requirements can be determined.

- If a branch circuit breaker of a known amperage will be used, match this rating with the heat trace selection and the temperature at which the heat trace will be energized.
- If no circuit breaker sizing has been established, find the maximum circuit length that meets or exceeds the length of the appropriate FLX at the start-up temperature of the heat trace and determine what amperage branch circuit breaker will be required.

Remember the start-up temperature does not necessarily match the expected low ambient.

Step 4: Choose FLX Options

To ensure that the proper FLX heat trace is purchased, some additional heat trace choices must be made.

All FLX self-regulating heat trace includes a tinned copper braid and polyolefin outer jacket as standard equipment. This outer jacket, designated by an OJ suffix added to the heat trace's catalog nomenclature (i.e., 5-FLX-1-OJ), provides additional mechanical protection for the heat trace.

Additional environmental barriers are available to provide corrosion protection for the tinned copper braid in locations subject to hydrocarbon-based chemical solutions.

- Fluoropolymer outer jacket for organic chemicals or corrosives (an FOJ suffix is added to the FLX catalog number; i.e., 5-FLX-1-FOJ).

Table 3.1 Valve, Pump, and Flange Allowances' (Metric Values)

Pipe Size (DN)	Valve Allowance (meters)			Pump Allowance (meters)		Flange Allowance (meters)
	Screwed or Welded	Flanged	Butterfly	Screwed	Flanged	
15	0.20	0.38	0.00	0.30	0.61	0.38
20	0.20	0.46	0.00	0.46	0.91	0.46
25	0.30	0.61	0.30	0.61	1.22	0.46
32	0.50	0.61	0.30	0.91	1.37	0.53
40	0.50	0.76	0.46	0.91	1.52	0.61
50	0.60	0.76	0.61	1.22	1.68	0.61
80	0.80	1.07	0.76	1.52	2.13	0.69
100	1.20	1.52	0.91	2.44	3.05	0.84
150	2.10	2.44	1.07	4.27	4.88	0.99
200	2.90	3.35	1.22	5.79	6.71	1.14
250	3.80	4.27	1.22	7.62	8.53	1.30
300	4.60	5.03	1.52	9.14	10.06	1.52
350	5.50	5.94	1.68	10.97	11.89	1.68
400	6.60	7.01	1.83	13.11	14.02	1.83
450	7.80	8.23	1.98	15.54	16.46	1.98
500	8.70	9.14	2.13	17.37	18.29	2.21
600	10.40	10.97	2.44	20.73	21.95	2.51
750	12.20	12.80	3.05	24.38	25.60	3.05

Table 3.2 Valve, Pump, and Flange Allowances' (Imperial Values)

Pipe Size (NPS)	Valve Allowance (feet)			Pump Allowance (feet)		Flange Allowance (feet)
	Screwed or Welded	Flanged	Butterfly	Screwed	Flanged	
½"	6"	1' 3"	0	1'	2'	1' 3"
¾"	9"	1' 6"	0	1' 6"	3'	1' 6"
1"	1'	2'	1'	2'	4'	1' 6"
1¼"	1' 6"	2'	1'	3'	4' 6"	1' 9"
1½"	1' 6"	2' 6"	1' 6"	3'	5'	2' 0"
2"	2'	2' 6"	2'	4'	5' 6"	2' 0"
3"	2' 6"	3' 6"	2' 6"	5'	7'	2' 3"
4"	4'	5'	3'	8'	10'	2' 9"
6"	7'	8'	3' 6"	14'	16'	3' 3"
8"	9' 6"	11'	4'	19'	22'	3' 9"
10"	12' 6"	14'	4'	25'	28'	4' 3"
12"	15'	16' 6"	5'	30'	33'	5' 0"
14"	18'	19' 6"	5' 6"	36'	39'	5' 6"
16"	21' 6"	23'	6'	43'	46'	6' 0"
18"	25' 6"	27'	6' 6"	51'	54'	6' 6"
20"	28' 6"	30'	7'	57'	60'	7' 3"
24"	34'	36'	8'	68'	72'	8' 3"
30"	40'	42'	10'	80'	84'	10' 0"

Note

1. The valve allowance given is the total amount of trace heater installed on the valve in addition to the through length. If multiple trace heaters are used, the total valve allowance may be divided among the additional trace heaters. The total valve allowance may be alternated among trace heaters for multiple valves in a heat trace circuit. Allowances are for typical Class 150 valves, pumps, and flanges. Additional trace heater length may be required to offset heat loss. Refer to isometric system drawings or other applicable documents provided by Thermon for allowances specific to each line and circuit.

Table 3.3 120 Vac

120 Vac Service Voltage ¹		Max. Circuit Length ³ vs. Breaker Size m (ft)		
Catalog Number	Start-Up Temp. °C (°F) ²	Max. Circuit Length ³ vs. Breaker Size m (ft)		
		20 A	30 A	40 A
3-FLX-1	10 (50)	108 (354)	108 (354)	108 (354)
	0 (32)	108 (354)	108 (354)	108 (354)
	-20 (-4)	96 (315)	108 (354)	108 (354)
	-40 (-40)	79 (259)	108 (354)	108 (354)
5-FLX-1	10 (50)	73 (240)	88 (289)	88 (289)
	0 (32)	73 (240)	88 (289)	88 (289)
	-20 (-4)	61 (200)	88 (289)	88 (289)
	-40 (-40)	50 (164)	76 (249)	81 (266)
8-FLX-1	10 (50)	58 (190)	81 (266)	81 (266)
	0 (32)	57 (187)	81 (266)	81 (266)
	-20 (-4)	44 (144)	67 (220)	79 (259)
	-40 (-40)	37 (121)	55 (180)	65 (213)
10-FLX-1	10 (50)	48 (157)	66 (217)	66 (217)
	0 (32)	42 (138)	63 (207)	66 (217)
	-20 (-4)	33 (108)	50 (164)	66 (217)
	-40 (-40)	27 (89)	41 (135)	55 (180)

Table 3.4 240 Vac

240 Vac Service Voltage ¹		Max. Circuit Length ³ vs. Breaker Size m (ft)		
Catalog Number	Start-Up Temp. °C (°F) ²	Max. Circuit Length ³ vs. Breaker Size m (ft)		
		20 A	30 A	40 A
3-FLX-2	10 (50)	214 (702)	214 (702)	214 (702)
	0 (32)	214 (702)	214 (702)	214 (702)
	-20 (-4)	192 (630)	214 (702)	214 (702)
	-40 (-40)	158 (518)	214 (702)	214 (702)
5-FLX-2	10 (50)	146 (479)	178 (584)	178 (584)
	0 (32)	146 (479)	178 (584)	178 (584)
	-20 (-4)	117 (384)	175 (574)	178 (584)
	-40 (-40)	96 (315)	145 (476)	163 (535)
8-FLX-2	10 (50)	117 (384)	154 (505)	154 (505)
	0 (32)	108 (354)	154 (505)	154 (505)
	-20 (-4)	84 (276)	127 (417)	154 (505)
	-40 (-40)	69 (226)	104 (341)	131 (430)
10-FLX-2	10 (50)	96 (315)	133 (436)	133 (436)
	0 (32)	85 (279)	127 (417)	133 (436)
	-20 (-4)	67 (220)	101 (331)	133 (436)
	-40 (-40)	55 (180)	83 (272)	111 (364)

Table 3.5 230 Vac

230 Vac Service Voltage ¹		Max. Circuit Length ³ vs. Breaker Size m (ft)					
Catalog Number	Start-Up Temp. °C (°F) ²	Type B			Type C		
		16 A	25 A	32 A	16 A	25 A	32 A
3-FLX-2	10 (50)	191 (627)	220 (722)	220 (722)	191 (627)	220 (722)	220 (722)
	0 (32)	191 (627)	220 (722)	220 (722)	191 (627)	220 (722)	220 (722)
	-20 (-4)	156 (512)	220 (722)	220 (722)	156 (512)	220 (722)	220 (722)
	-40 (-40)	127 (417)	199 (653)	220 (722)	127 (417)	199 (653)	220 (722)
5-FLX-2	10 (50)	117 (384)	176 (577)	176 (577)	117 (384)	176 (577)	176 (577)
	0 (32)	117 (384)	176 (577)	176 (577)	117 (384)	176 (577)	176 (577)
	-20 (-4)	98 (322)	153 (502)	176 (577)	98 (322)	153 (502)	176 (577)
	-40 (-40)	80 (262)	126 (413)	161 (528)	80 (262)	126 (413)	161 (528)
8-FLX-2	10 (50)	93 (305)	146 (479)	147 (482)	93 (305)	146 (479)	147 (482)
	0 (32)	93 (305)	146 (479)	147 (482)	93 (305)	146 (479)	147 (482)
	-20 (-4)	74 (243)	116 (381)	147 (482)	74 (243)	116 (381)	147 (482)
	-40 (-40)	61 (200)	95 (312)	122 (400)	61 (200)	95 (312)	122 (400)
10-FLX-2	10 (50)	66 (217)	104 (341)	132 (433)	77 (253)	120 (394)	132 (433)
	0 (32)	58 (190)	91 (299)	117 (384)	71 (233)	111 (364)	132 (433)
	-20 (-4)	46 (151)	71 (233)	92 (302)	55 (180)	87 (285)	111 (364)
	-40 (-40)	37 (121)	58 (190)	75 (246)	45 (148)	71 (233)	91 (299)

Notes

1. Circuit breaker sizing and earth/ground-fault protection should be based on applicable local codes. Earth/ground-fault protection of equipment should be provided for each branch circuit supplying electric heating equipment. For the maximum circuit length at other service voltages, please contact Thermon.
2. While a heat tracing system is generally designed to keep the contents of a pipe at the desired maintain temperature, the trace heater may be energized at lower temperatures. For design data with lower start-up temperatures than represented above contact Thermon for design assistance.
3. The maximum circuit length is for one continuous length of trace heater, not the sum of segments of cable. Refer to CompuTrace® design software or contact Thermon for current loading of segments.

Nomenclature for Ordering Following is an example of a typical catalog number for FLX:

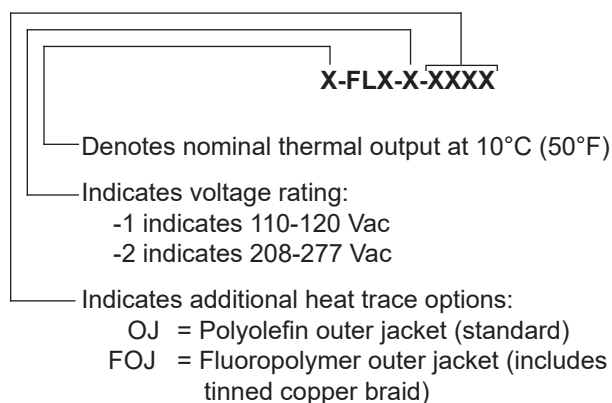

Example From the information obtained in Steps 1, 2 and 3, suppose an 8-FLX-1 heat trace will be required for a project. Since the application will have exposure to sea air, a standard polyolefin outer jacket is desired. The proper FLX for this application is: **8-FLX-1-OJ**.

FLX™ Self-Regulating Heat Tracing

Step 5: Choose FLX Installation Accessories

An FLX self-regulating freeze protection heat tracing system will typically include the following components:

1. **FLX** self-regulating heat trace (refer to Design Selection Charts 2.1 and 2.2 for proper heat trace).
2. **PCA-COM** circuit fabrication kit (shown with optional **JB-K** junction box).
3. **PCS-COM** in-line/T-splice kit (permits two or three trace heaters to be spliced together).
4. **ET-6** (for OJ heat trace) end termination. Each PCA-COM and PCS-COM includes one ET-6 end cap.
5. **FT-1L** fixing tape secures heat trace to pipe; use on 300 mm (12") intervals or as required by code or specification. Use Table 5.1 to determine tape requirements.
6. **CL** "Electric Heat Tracing" label (peel-and-stick label attaches to insulation vapor barrier on 3 m (10') intervals or as required by code or specification).
7. Fiberglass thermal insulation and vapor barrier (by others).

As a minimum, each FLX heat tracing circuit requires a PCA-COM circuit fabrication kit and FT-1L fixing tape.

Use Table 5.1 to calculate the number of rolls of FT-1L fixing tape required based on the pipe diameter(s) and total length of heat trace required.

Table 5.1 FT-1L Fixing Tape Allowance
Meters (Feet) of Pipe Per Roll of Tape

Tape Length m (ft)	Pipe Diameter DN (NPS)															
	15-25 (½-1)	32 (1¼)	40 (1½)	50 (2)	80 (3)	100 (4)	150 (6)	200 (8)	250 (10)	300 (12)	350 (14)	400 (16)	450 (18)	500 (20)	600 (24)	750 (30)
33 (108)	40 (130)	35 (115)	34 (110)	29 (95)	23 (75)	20 (65)	15 (50)	12 (40)	11 (35)	9 (30)	8 (26)	7 (23)	6 (21)	6 (19)	5 (16)	4 (13)
55 (180)	66 (215)	59 (195)	55 (180)	49 (160)	38 (125)	32 (105)	24 (80)	20 (65)	17 (55)	15 (50)	13 (43)	12 (38)	11 (35)	9 (31)	8 (27)	7 (22)

For nonmetallic piping applications requiring AL-20L aluminum tape, plan for one foot of tape for each foot of heat trace. AL-20L is available in 51 mm x 46 m (2" x 150') rolls.

Notes

- All heat-traced lines must be thermally insulated.
- Circuit fabrication kits do not include electrical junction boxes.
- Thermostatic control (not shown) is recommended for all freeze protection and temperature maintenance trace heating applications (see page 13).
- 30 mA ground-fault equipment protection is to be used for all trace heating circuits.

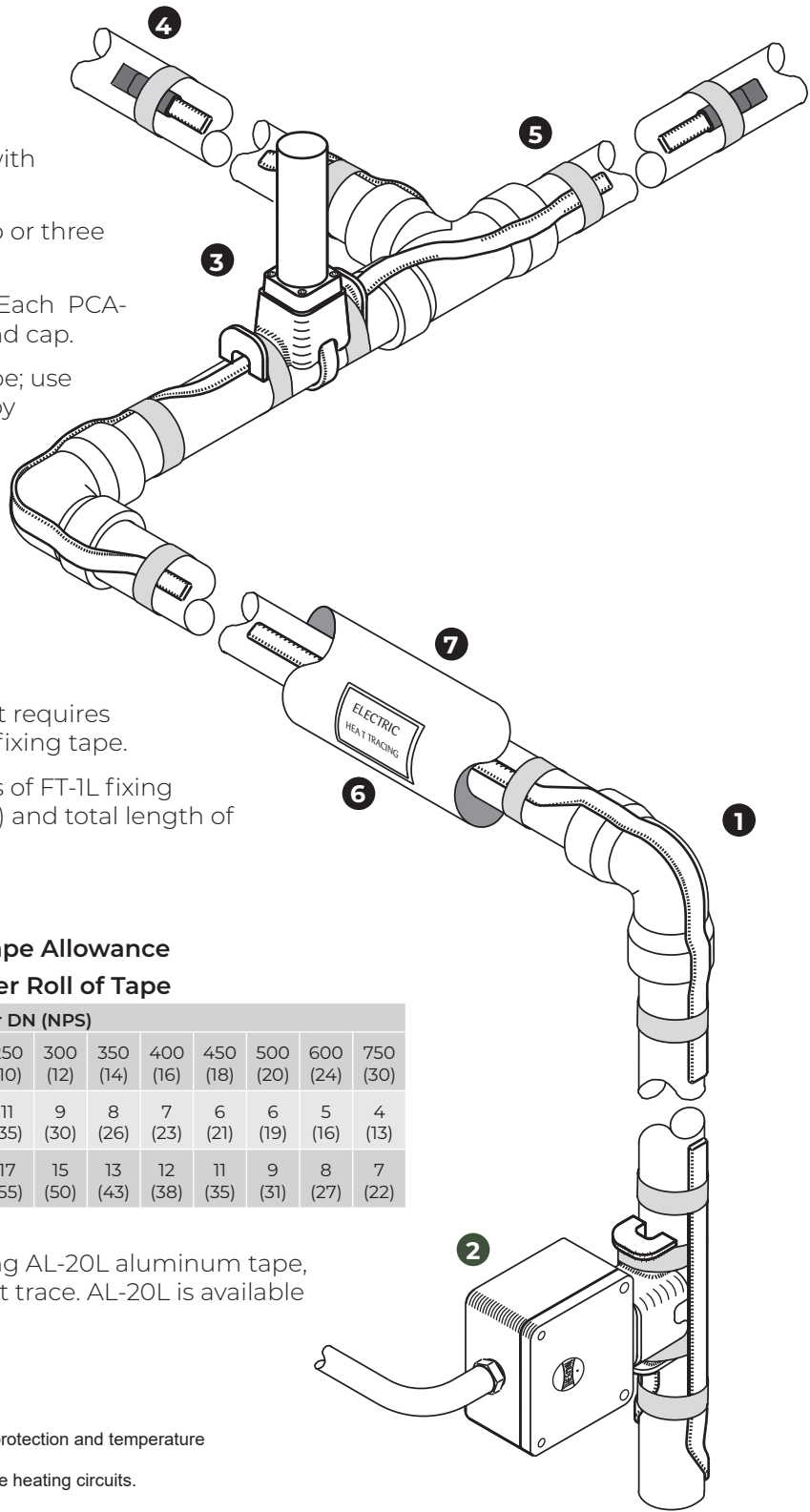

Installation Guidelines for Fire Protection Systems

1. Where above ground water-filled supply pipes, risers, system risers or feed mains pass through open areas, cold rooms, passageways, or other areas exposed to freezing temperatures, the pipe shall be protected against freezing in accordance with NFPA 13, "Standard for the Installation of Sprinkler Systems".

2. Thermon's FLX Self-Regulating Heat Traces is approved for use on Fire Protection System Piping feed mains, risers, and cross mains. This application approval includes piping which connects between buildings in unheated areas, piping located in unheated areas or piping through coolers or freezers. As with all heat traced piping systems, thermal insulation is required to ensure the heating system can compensate for heat losses.

3. In accordance with IEEE 515.1 guidelines, the use of ambient sensing control with low temperature and continuity monitoring as a minimum for all fire protection piping heat tracing systems is required. Thermon recommends the use of the Thermon TCM2 electronic controller for these applications, having capability of annunciating the following faults/alarms locally as well as remotely:

- Ground / Earth fault
- Low temperature
- High temperature
- Sensor failure
- Controller failure
- Low current
- Circuit fault
- High temperature limit controller, if provided.

4. Pipe sections that lie in different ambient conditions (e.g. inside the building (heated areas) and outside the building) should not be under the same temperature control zone.

5. The heat tracing system shall be designed to maintain the pipe temperatures between 4°C and 38°C, or if necessary for the installation, an additional 'Hi Temp' limit sensor should be included to limit the runaway pipe temperature within 55°C or 8°C below the sprinkler temperature rating, whichever is lower. A low-temperature alarm with contacts for a remote annunciation shall be provided for each fire sprinkler line trace heating circuit with a set-point of 2°C.

6. The alarms of sprinkler system temperature/ electrical control shall be connected to a fire detection alarm system monitoring.

7. Both of the two basic sprinkler system types i.e. wet (where the branch lines are always filled with water) and dry type (where the sprinkler head/sensor activates the upstream control valve) require heat tracing for the branch lines up to the sprinkler head.

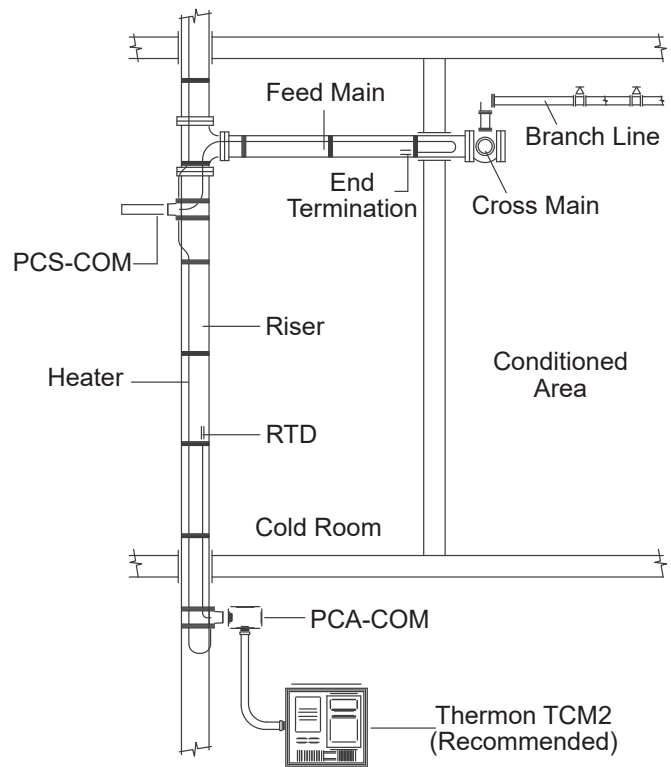

In case of dry type, the tracing is meant to keep the empty branch pipes above freezing point, so that when upstream control valve operates the pipe body does not cool down the incoming water.

8. Trace heating systems for fire sprinkler systems shall be permanently connected to the power supply.

9. The heat tracer braid shall be connected to earth / ground terminal at every termination and suitable external grounding.

10. If backup power is being provided for the building electrical systems, it shall also provide backup power supply for the trace heating system or equivalent.

THE NFPA DEFINES THE FOLLOWING:

Branch Lines—The pipes in which the sprinklers are placed, either directly or through risers.

Cross Mains—The pipes supplying the branch lines, either directly or through risers.

Feed Mains—The pipes supplying cross mains, either directly or through risers.

Risers—The vertical supply pipes in a sprinkler system.

FLX™ Self-Regulating Heat Tracing

Design Worksheet

Once the information relating to the design parameters has been obtained and the design steps have been followed, an FLX heat tracing bill of materials may be generated using this worksheet.

Step 1: Establish Design Parameters

Collect information for each pipe/heat tracing circuit relative to the following design parameters:

Application Information

Piping:

Metallic vs. Nonmetallic	Length	Diameter
_____	_____	_____
_____	_____	_____
_____	_____	_____

Equipment—Type and Number of:
Valves Pumps Misc. Equip.

_____	_____	_____
_____	_____	_____
_____	_____	_____

Pipe Supports:

Type/Length	Number
_____	_____
_____	_____
_____	_____

Expected Temperatures

Minimum ambient	_____
Minimum start-up temp.	_____
Maintain temperature	_____

Insulation Thickness

Assumed Fiberglass: Pipe Diameter	Insul. Thick.	Nom. Insul. Size
_____	_____	_____
_____	_____	_____
_____	_____	_____

Electrical Information

Supply voltage	_____
Circuit breaker size	_____

Step 2: Select the Proper FLX Heat Trace

Using the information gathered in Step 1, refer to Design Selection Chart 2.1 (for metallic piping) or Design Selection Chart 2.2 (for nonmetallic piping). Remember to select the proper FLX self-regulating heat trace based on the minimum ambient temperature expected.

Step 3: Determine FLX Circuit Lengths

Use Table 3.2 (120 Vac) or Table 3.3 (240 Vac) to determine the maximum circuit length based on the circuit breaker size and start-up temperature. Record the information below:

FLX	Voltage Vac	Start-Up Temperature	Ckt. Brkr. Size	Max. Ckt. Length
_____	_____	_____	_____	_____
_____	_____	_____	_____	_____
_____	_____	_____	_____	_____
_____	_____	_____	_____	_____

Step 4: Choose FLX Options

Determine the proper FLX options required to meet the installation. All FLX is equipped with a standard tinned copper braid and polyolefin outer jacket.

Check the other options required:

- OJ Polyolefin outer jacket (standard)
- FOJ Fluoropolymer outer jacket

Step 5: Choose FLX Installation Accessories

- PCA-COM** circuit fabrication kit
- PCS-COM** in-line/T-splice kit
- FT-IL** fixing tape
- AL-20L** aluminum tape (for nonmetallic piping)
- CL** "Electric Heat Tracing" label
- B4X-15140** adjustable ambient sensing thermostat
- E4X-1 & E4X-35235** adjustable pipewall sensing thermostats
- JB-K** junction box

Design Tips

To ensure a properly operating heat tracing system and avoid the common mistakes made by first-time users, the following tips have been compiled:

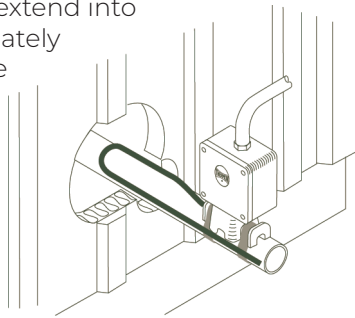
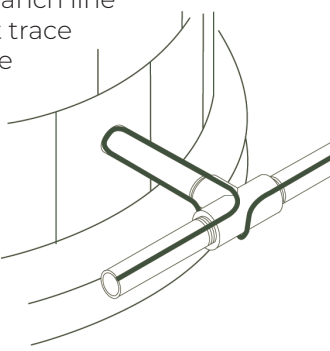
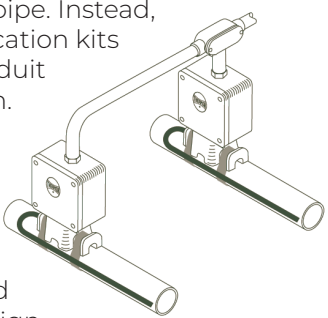
1. When a heat-traced pipe enters a facility, the heat trace should extend into the building approximately 300 mm (12") to ensure the pipe temperature is maintained. This prevents temperature drops due to air gaps or compression of the thermal insulation. 
2. A similar situation exists when an above ground pipe goes underground. While the pipe may eventually travel below the frost line and therefore be protected from freezing, the distance between the surface (grade) and the frost line must be protected. This can be accomplished by creating a loop with the heat trace end terminated above the normal water line. If the application is temperature maintenance, the above grade and below grade portions should be controlled as separate circuits due to the differing surrounding environments.
3. Where a freeze protection application has a main line with a short branch line connected to it, the heat trace installed on the main line can be looped (double passed) on the branch line. This eliminates the need to install a T-splice kit. 
4. All of the heat trace power connection points should be secured to the piping. Heat trace should not pass through the air to travel to an adjoining pipe. Instead, use multiple circuit fabrication kits interconnected with conduit and field wiring as shown. 

Thermostatic Control

While the five steps in the design and selection process provide the detailed information required to design, select and/or specify an FLX self-regulating heat tracing system, some type of control will typically be needed. The type of control and level of sophistication needed will depend entirely

on the application of the piping being heat-traced. Self-regulating heat trace can, under many design conditions, be operated without the use of any temperature control; however, some method of control is generally used and the two most common methods are ambient sensing and pipewall sensing. Each method has its own benefits, and various options are available within each method.

Ambient Sensing An adjustable thermostat, designed for mounting in an exposed environment, senses the outside air temperature. When this temperature falls below the set point, a set of contacts close and energize the heat trace. Should the electrical load of the heating circuit exceed the rating of the thermostat switch, a mechanical contactor can be used. An entire power distribution panel, feeding dozens of heat tracing circuits, can be energized through an ambient sensing thermostat.

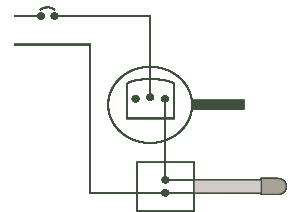

The primary application for ambient sensing control of electric heat tracing is freeze protection (winterization) of water and water-based solutions. A benefit of ambient sensing control for freeze protection is that pipes of varying diameters and insulation thicknesses can be controlled as a single circuit.

By controlling heat tracing with ambient sensing control, the status (flowing or nonflowing) of the heated pipe needs no consideration.

Pipewall Sensing While a self-regulating heat trace adjusts its heat output to accommodate the surrounding conditions, the most energy-efficient method for controlling heat tracing is a pipewall sensing thermostat. This is because a flowing pipe will typically not need any additional heat to keep it at the proper temperature. Where a piping system has tees and therefore multiple flow paths, more than one thermostat may be required. Situations where more than one thermostat could be necessary include:

- Pipes of varying diameters or insulation thicknesses.
- Varying ambient conditions such as above/below ground transitions and indoor/outdoor transitions.
- Flowing versus nonflowing conditions within the interconnected piping.
- Applications involving temperature-sensitive products.

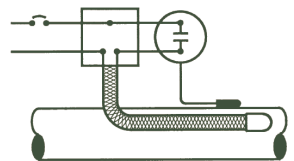

FLX™ Self-Regulating Heat Tracing

General Specification

Part 1 General

Furnish and install a complete system of heaters and components approved specifically for pipe heat tracing. The heat tracing system shall conform to ANSI/IEEE Standard 515.1.

Part 2 Products

1. The self-regulating heater shall consist of two nickel-plated copper bus wires embedded in a radiation cross-linked semiconductive polymer core. The heater shall be capable of varying its heat output along its entire length, allowing the heater to cross over itself without overheating. The heater shall be covered by a polyolefin dielectric jacket and a tinned copper braid.
2. In addition to a tinned copper braid, the heat trace shall be covered by (select):
 - a. A polyolefin outer jacket for protection from aqueous inorganic chemicals (standard construction).
 - b. A fluoropolymer outer jacket for protection from organic chemicals or corrosives (optional).
3. The heater shall operate on a line voltage of (select 110-120 or 208-277) Vac without the use of transformers.
4. The heat trace shall be suitable for use on metallic and nonmetallic piping. On nonmetallic piping, the heat trace shall be attached to the pipe with a parallel covering of aluminum tape.
5. For additional energy conservation, the heat trace shall be controlled by (select):
 - a. An adjustable ambient sensing thermostat with a switch rating of 22 A.
 - b. A bimetallic pipewall sensing thermostat preset at 5 C° (40°F) with a switch rating of 22 A at 120/240/277 Vac based on current loads for each circuit.
 - c. An adjustable pipewall sensing thermostat with a switch rating of 30/25 amps at 240/277 Vac.
 - d. Where the load of the heat trace exceeds the rating of the thermostat, the heat trace shall be controlled through an appropriately sized contactor by the control thermostat.
6. All heat trace cores will be permanently marked with the manufacturer's identification number for traceability.
7. Acceptable products and manufacturers: FLX™ and accessories as manufactured by Thermon.
8. Refer to the manufacturer's freeze protection design guide for design details, insulation requirements, maximum circuit lengths and accessory information.

Part 3 Manufacturer

1. Manufacturer shall demonstrate experience manufacturing and designing freeze protection

systems with self-regulating heat trace. This experience may be documented with a list of ___ projects utilizing at least 600 meters (2,000 feet) of self-regulating heat trace.

2. Manufacturer's Quality Assurance Program shall be certified to the ISO 9001 Standard.

Part 4 Installation

1. Refer to the manufacturer's installation instructions and design guide for proper installation and layout methods. Deviations from these instructions could result in performance characteristics different than intended.
2. All installations and terminations must conform to the National Electrical Code and any other applicable national or local code requirements.
3. Circuit breakers supplying power to the heat tracing shall be equipped with 30 mA ground-fault equipment protection.
4. Piping shall be pressure tested prior to installation of heat trace. Thermal insulation shall not be installed until heat trace installation is complete and a megohmmeter (megger) test has been passed (see Testing, Part 5). Heat-traced lines shall be insulated promptly after the heat tracing installation.
5. The insulation shall not be installed with staples. Insulation jackets should be closed with adhesive to avoid damage to the heat trace.
6. System shall be connected to power by the electrician (see Division 16-Electrical).

Part 5 Testing

1. Heat trace shall be tested with a megohmmeter (megger) between the heat trace bus wires and the metallic ground braid. While a 2,500 Vdc megger test is recommended, the minimum acceptable level for testing is 500 Vdc. This test should be performed a minimum of three times:
 - a. Prior to installation while the heat trace is still on reel(s).
 - b. After installation of heat trace and completion of circuit fabrication kits (including any splice kits) but prior to installation of thermal insulation.
 - c. After installation of thermal insulation but prior to connection to power.
2. The minimum acceptable level for the megger readings is 20 megohms, regardless of the circuit length.
3. Results of the megger readings shall be recorded and submitted to the construction manager.



Corporate Headquarters: 7171 Southwest Parkway · Building 300, Suite 200 · Austin, TX 78735 · Phone: 512-690-0600
For the Thermon office nearest you visit us at . . . www.thermon.com

Form CPD1008-0222

© Thermon, Inc. · Printed in U.S.A. · Information subject to change.