

FAK-4S and FAK-4LS

Temperature Sensor Kit
For TubeTrace® Bundles

INSTALLATION PROCEDURES



FAK-4S/FAK-4LS: Temperature Sensor Kit

The FAK-4S/FAK-4LS: Installation Kit is designed to make a waterproof seal over TubeTrace at the Temperature Sensor Installation location.

Receiving, Storing and Handling

1. Inspect materials for damage incurred during shipping.
2. Report damages to the carrier for settlement.
3. Identify parts against the packing list to ensure the proper type and quantity has been received.
4. Store in dry location.
5. Ensure that temperature sensor is suitable for area classification.
6. Any modifications to the enclosure or deviation from these procedures may affect unit's rating or approvals. Contact factory if modifications are necessary.

Dimensions

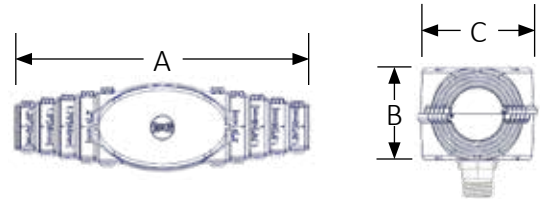

	A mm (inch)	B mm (inch)	C mm (inch)
FAK-4S	279 mm (11")	64 mm (2-1/2")	81 mm (3-1/5")
FAK-4LS	489 mm (19-1/4")	111 mm (4-3/8")	141 mm (5-1/2")

FAK-4S: Thermostat Installation Kit Contents

Item	Quantity	Description
1	1	Sensor Cover (Top)
2	1	Sensor Cover (Bottom)
3	1	Silicone Gasket
4	1	Self-Vulcanizing Tape
5	1	Heat Reflective Tape
6	1	Glass Fiber Tape
7	2 (FAK-4S) 3 (FAK-4LS)	RTV Sealant Tube
8a	1	Sensor Head Mounting Assembly
8b	1	RTO Sensor (Optional or by Others)

Installation Precautions

- To minimize the potential for arcing and ground-fault protection. The National Electrical Code (NEC) and Canadian Electrical Code (CEC) require ground-fault protection of equipment for each branch circuit supplying electric heat tracing.
- Installation must comply with Thermon requirements and be installed in accordance with the NEC, CEC, or any other applicable national and local codes.
- Component approvals and performance ratings are based on the use of Thermon specified parts only. User supplied power connection fittings must be listed or certified for intended use.
- De-energize all power sources before opening enclosure.
- Keep ends of heating cable and kit components dry before and during installation.
- Individuals installing these products are responsible for complying with all applicable safety and health guidelines. Proper personal protective equipment, or PPE, should be utilized during installation. Contact Thermon if you have any additional questions.

FAK-4S/FAK-4LS: Thermostat Installation Kit

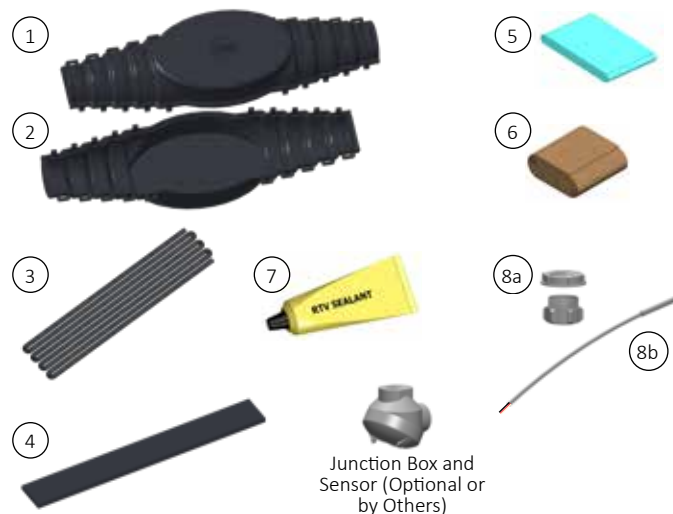

Tools Required



INSTALLATION PROCEDURES

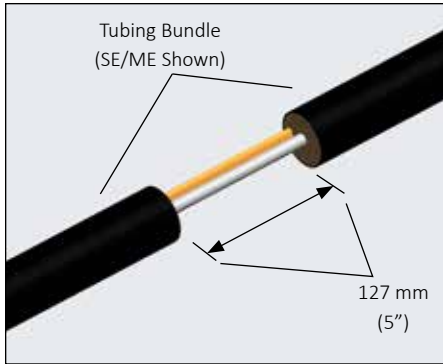

1. Remove outer jacket and insulation from tubing bundle approximately 127 mm (5") to expose the process tubes and heat trace.



CAUTION Do not cut or damage the heat trace or sampling tube.

(Found on TubeTrace SE/ME bundles)

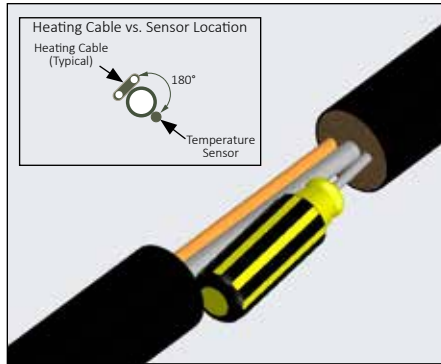

2. Prepare tubing bundle for temperature sensor by inserting a phillips screwdriver between the process tube(s) and insulation at a point opposite the heating cable. The sensor should be placed 180° around the circumference from the heating cable. Make sure that the entire length of the sensor is in intimate contact with the tube surface. Prevent kinking.



3. Insert the temperature sensor into the prepared hole in the thermal insulation. Ensure contact is maintained with the tube.

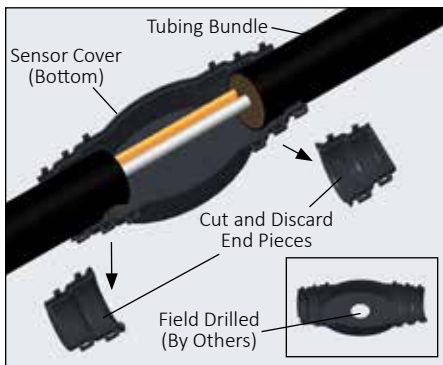

4. Using the dimensions on the sensor covers, locate the correct size, ensuring a snug fit. Identify the correct cut lines, and cut top and bottom sensor cover ends.

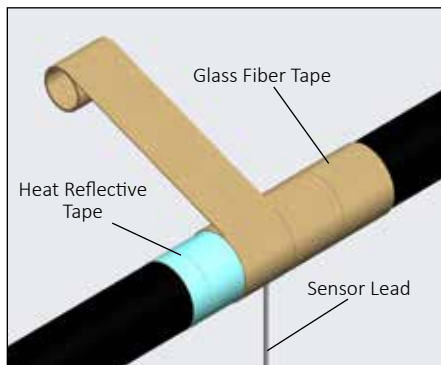

5. Wrap tubes and heat tracing with pass of heat reflective tape (25% overlap). Then wrap with 3 passes of glass fiber tape (50% overlap), or until fiber tape is equal to original bundle insulation thickness.

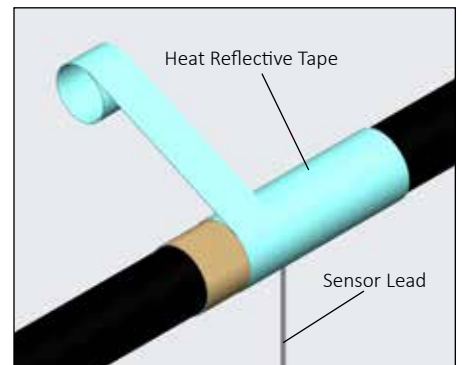

6. Complete with additional passes of heat reflective tape.

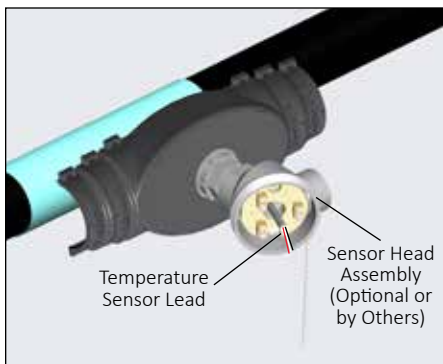

7. If applicable, connect sensor head assembly to the sensor cover bottom using the supplied hardware. Be sure temperature sensor lead is guided through the opening found in the middle of the terminal mount.

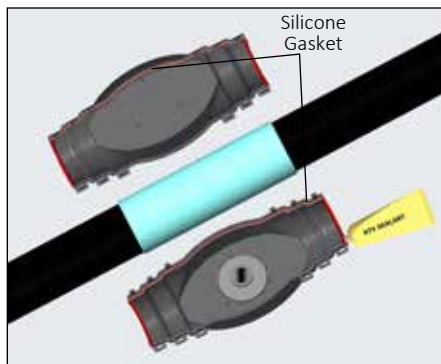

8. Install silicone gasket and cut off excess. Apply RTV sealant to both halves.

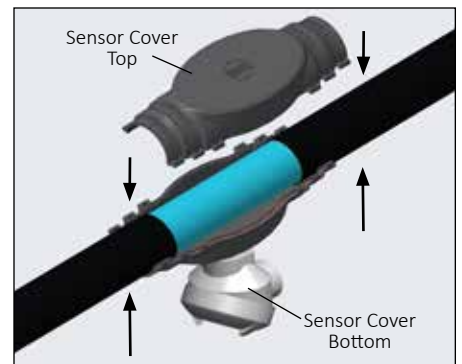

9. Assemble sensor top, tubing bundle, and sensor bottom together as shown. Snap both halves together firmly. Inspect cover ends for snug fit. Apply additional RTV sealant where needed.

FAK-4S/FAK-4LS: Temperature Sensor Kit



10. Apply Self-Vulcanizing Tape around bundle jacket and work up over FAK ends.

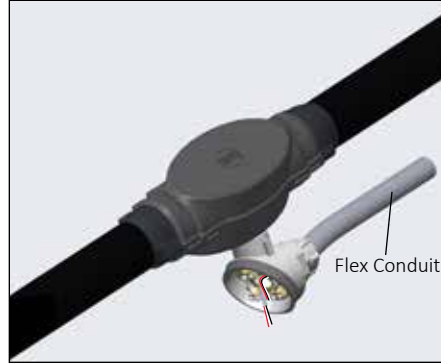

11. If applicable, connect flex conduit to sensor head assembly using hardware supplied by others. Be sure to guide power wires through opening found in the middle of the terminal mount.



12. If applicable, connect wires from conduit and temperature sensor to the terminals on the sensor head assembly. Tighten sensor head assembly lid.

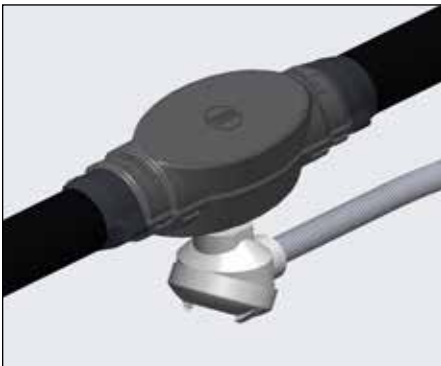

13. Completed FAK-4S/FAK-4LS

